

Machines Thermiques

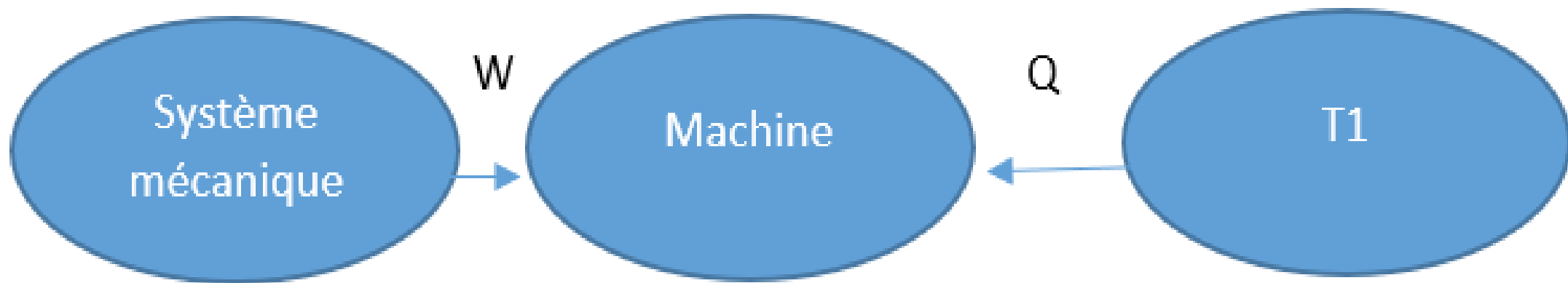

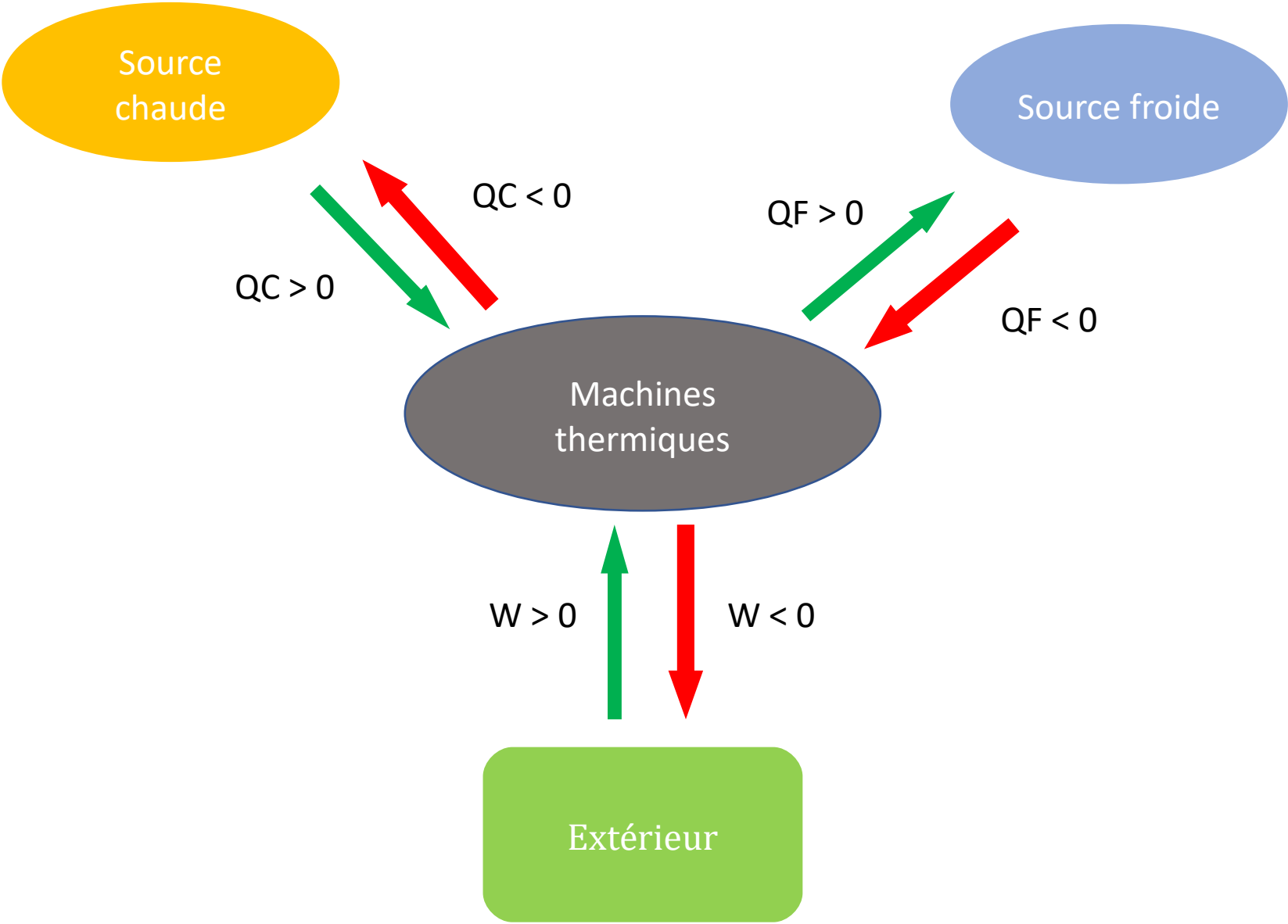

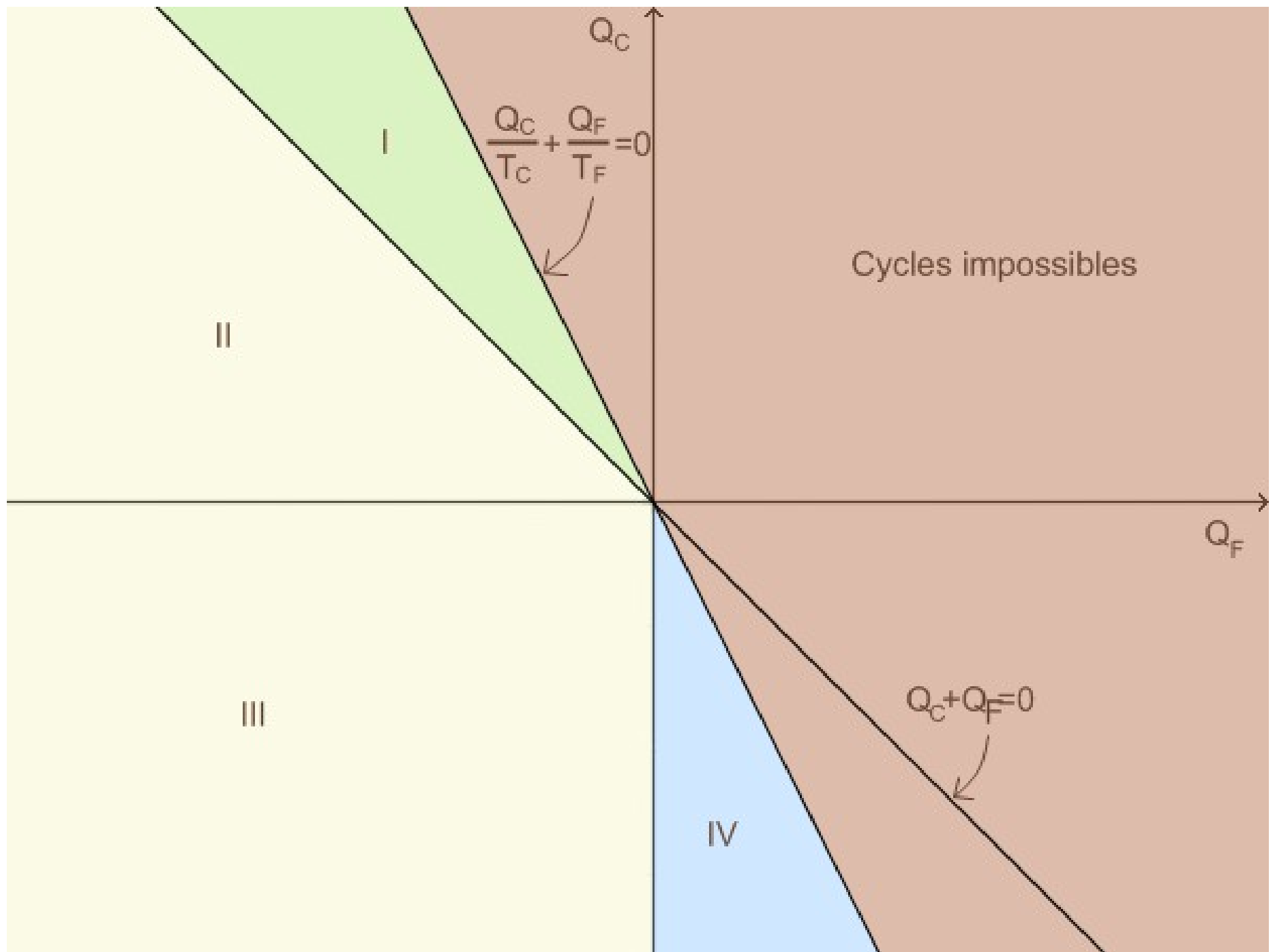

Moteur
thermique

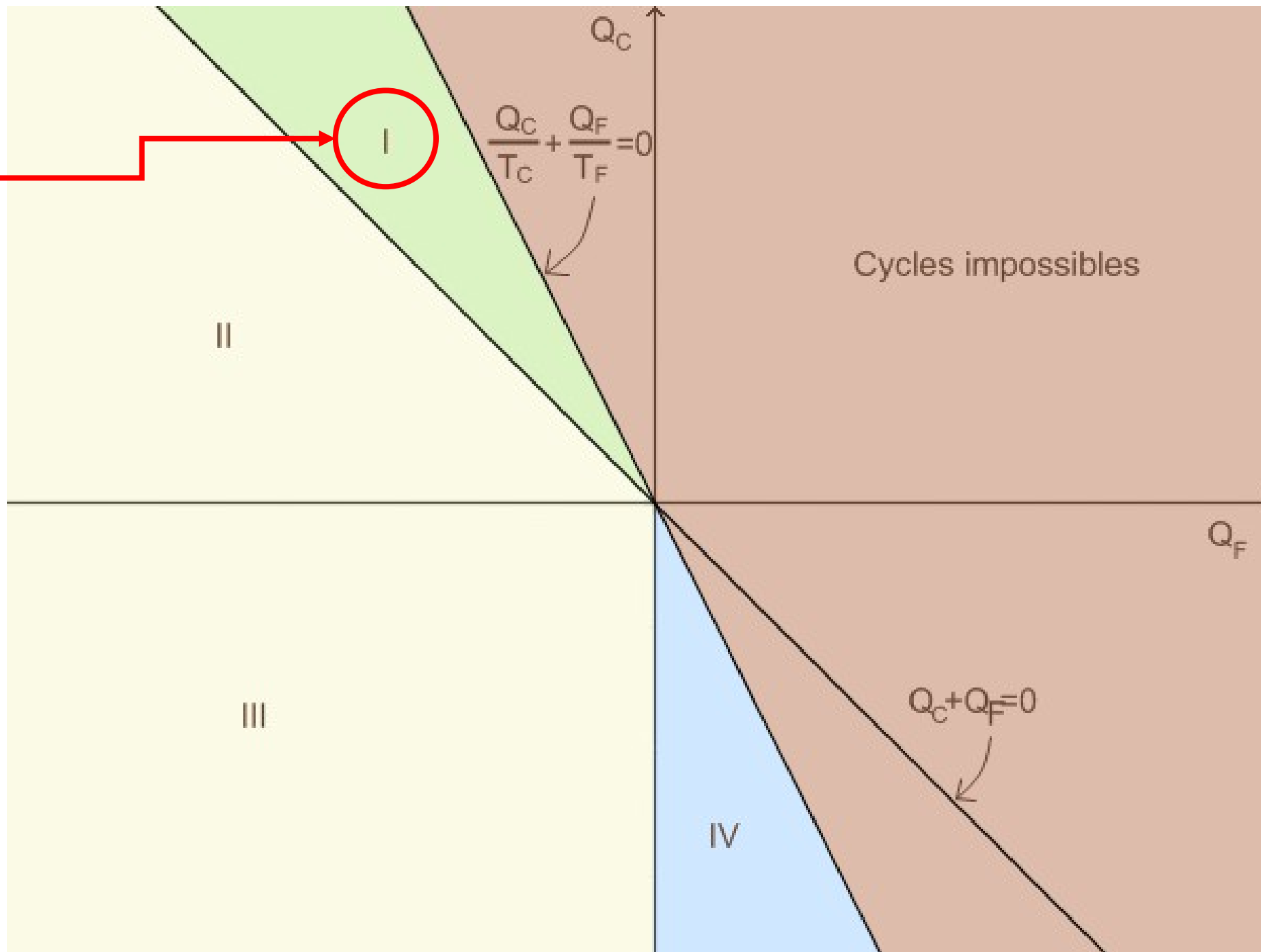

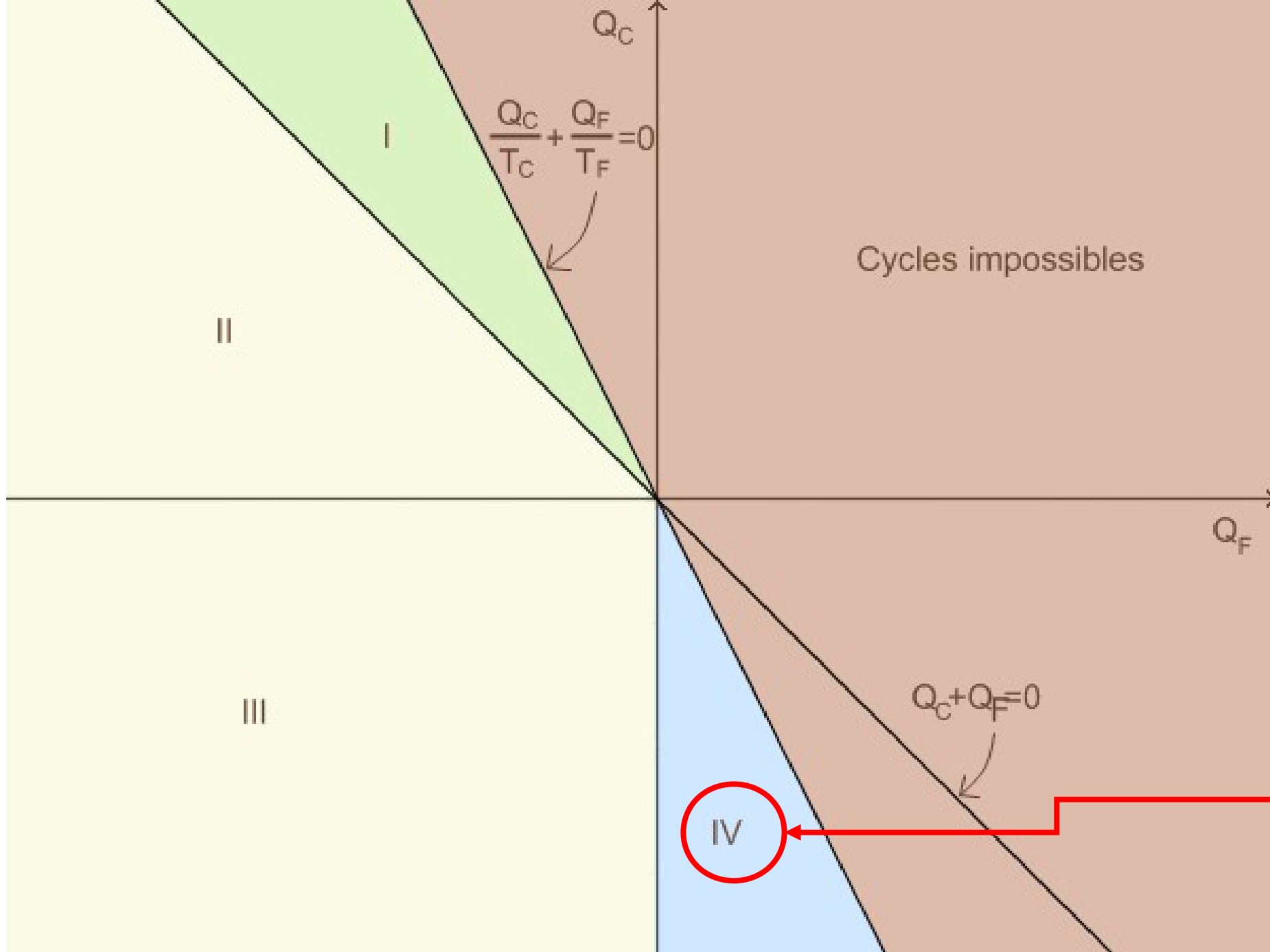

Récepteur
Thermique

Ev évaporateur

Cp compresseur

Cd Condenseur

Dx détendeur

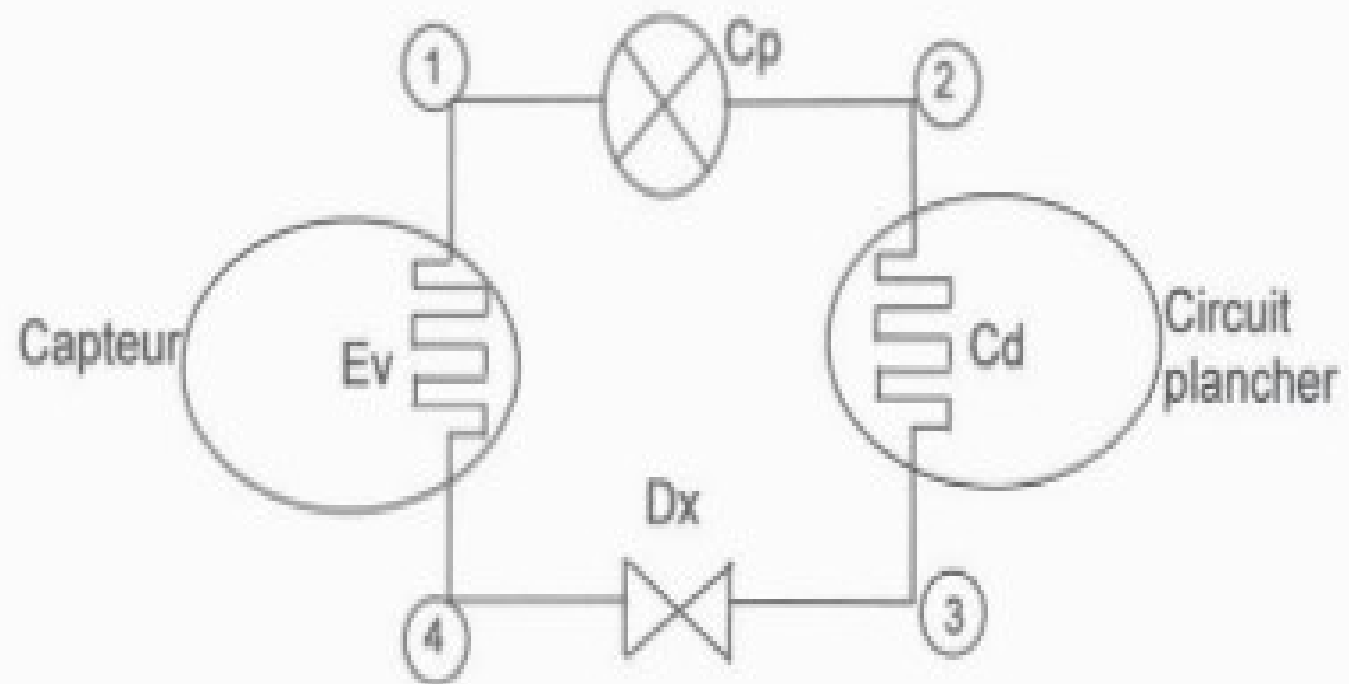

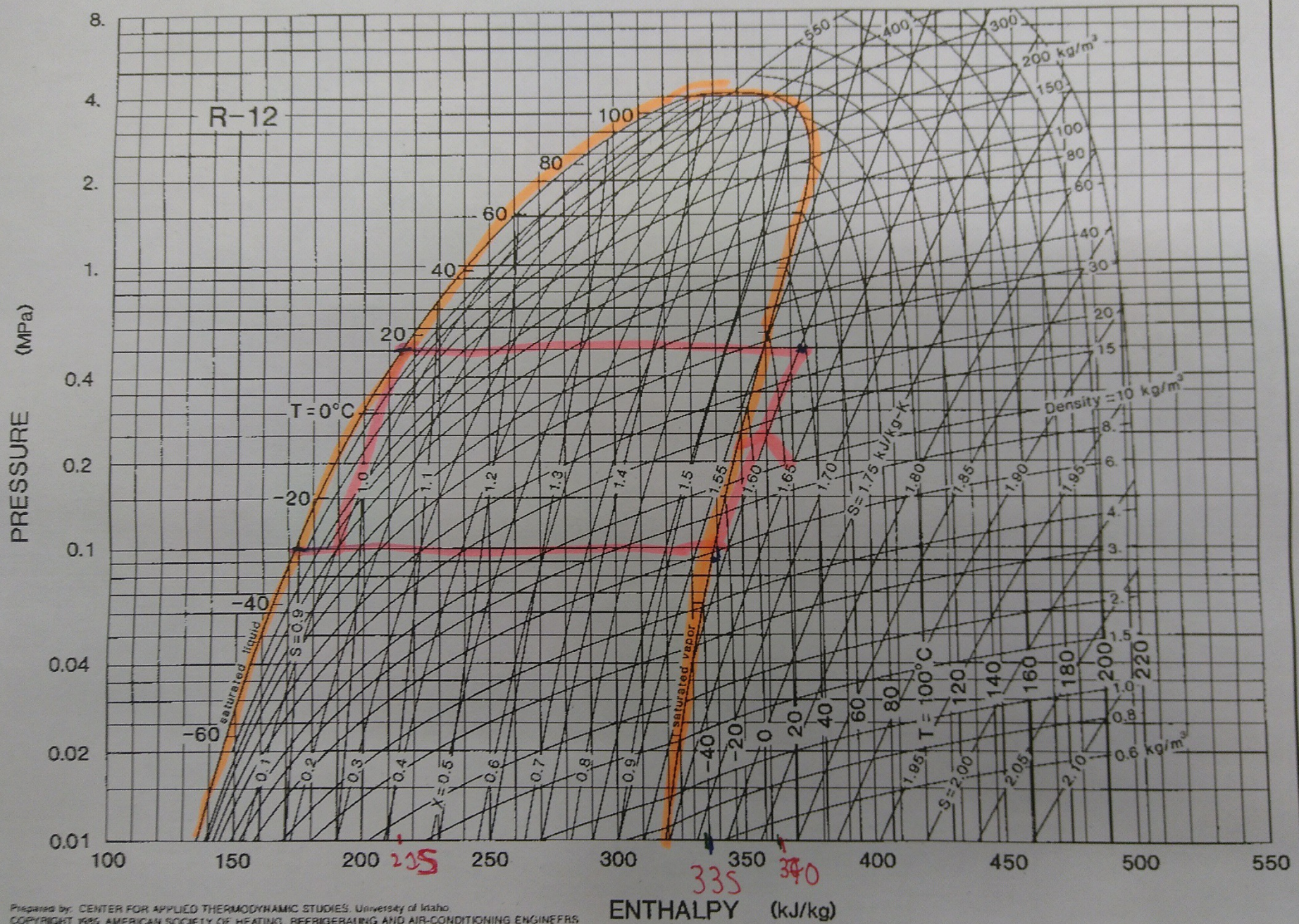

	Moteur	Pompe à chaleur	Machine frigorifique
Signes	$W < 0 ; QC > 0 ; QF < 0$	$W > 0 ; QC < 0 ; QF > 0$	$W > 0 ; QC < 0 ; QF > 0$
Grandeur d'intérêt	W	QC	QF
Grandeur coûteuse	QC	W	W