

Packing and covering immersion expansions of planar subcubic graphs^a

Archontia Giannopoulou^{b,c} O-joung Kwon^{d,e}
Jean-Florent Raymond^{b,f,g} Dimitrios M. Thilikos^{f,h}

Abstract

A graph H is an immersion of a graph G if H can be obtained by some subgraph G after lifting incident edges. We prove that there is a polynomial function $f : \mathbb{N} \times \mathbb{N} \rightarrow \mathbb{N}$, such that if H is a connected planar subcubic graph on $h > 0$ edges, G is a graph, and k is a non-negative integer, then either G contains k vertex/edge-disjoint subgraphs, each containing H as an immersion, or G contains a set F of $f(k, h)$ vertices/edges such that $G \setminus F$ does not contain H as an immersion.

keywords: Erdős–Pósa properties, Graph immersions, Packings and coverings in graphs

1 Introduction

All graphs in this paper are finite, undirected, loopless, and may have multiedges. Let \mathcal{C} be a class of graphs. An \mathcal{C} -*vertex/edge cover* of G is a set

^aAn extended abstract of this paper will appear in the proceedings of WG 2016. Emails: archontia.giannopoulou@gmail.com, ojoungkwon@gmail.com, jean-florent.raymond@mimuw.edu.pl, sedthilk@thilikos.info.

^bInstitute of Informatics, University of Warsaw, Poland.

^cSupported by the Warsaw Center of Mathematics and Computer Science.

^dInstitute for Computer Science and Control, Hungarian Academy of Sciences, Hungary.

^eSupported by ERC Starting Grant PARAMTIGHT (No. 280152).

^fAIGCo project team, CNRS, LIRMM, Montpellier, France.

^gSupported by the (Polish) National Science Centre grant PRELUDIUM 2013/11/N/ST6/02706.

^hDepartment of Mathematics, National and Kapodistrian University of Athens, Greece.

S of vertices/edges such that each subgraph of G that is isomorphic to a graph in \mathcal{C} contains some element of S . A \mathcal{C} -vertex/edge packing of G is a collection of vertex/edge-disjoint subgraphs of G , each isomorphic to some graph in \mathcal{C} .

We say that a graph class \mathcal{C} has the *vertex/edge Erdős–Pósa property* (shortly *v/e-E&P property*) for some graph class \mathcal{G} if there is a function $f : \mathbb{N} \rightarrow \mathbb{N}$, called a *gap function*, such that, for every graph G in \mathcal{G} and every non-negative integer k , either G has a vertex/edge \mathcal{C} -packing of size k or G has a vertex/edge \mathcal{C} -cover of size $f(k)$. In the case where \mathcal{G} is the class of all graphs we simply say that \mathcal{C} has the v/e-E&P property. An interesting topic in Graph Theory, related to the notion of duality between graph parameters, is to detect instantiations of \mathcal{C} and \mathcal{G} such that \mathcal{C} has the v/e-E&P property for \mathcal{G} and, if yes, optimize the corresponding gap. Certainly, the first result of this type was the celebrated result of Erdős and Pósa in [11] who proved that the class of all cycles has the v-E&P property with gap function $O(k \cdot \log k)$. This result have triggered a lot of research on its possible extensions. One of the most general ones was given in [25] where it was proven that the class of graphs that are contractible to some graph H have the v-E&P property iff H is planar (see also [4, 5, 8] for improvements on the gap function).

Other instantiations of \mathcal{C} for which the v-E&P property has been proved concern odd cycles [18, 21], long cycles [2], and graphs containing cliques as minors [9] (see also [14, 16, 23] for results on more general combinatorial structures).

As noticed in [8], cycles have the e-E&P property as well. Interestingly, only few more results exist for the cases where the e-E&P property is satisfied. It is known for instance that graphs contractible to θ_r (i.e. the graph consisting of two vertices and an edge of multiplicity r between them) have the e-E&P property [3]. Moreover it was proven that odd cycles have the e-E&P property for planar graphs [19] and for 4-edge-connected graphs [18].

Given two graphs G and H , we say that H is an *immersion* of G if H can be obtained from some subgraph of G by lifting incident edges (see Section 2 for the definition of the lift operation). Given a graph H , we denote by $\mathcal{I}(H)$ the set of all graphs that contain H as an immersion. Using this terminology, the edge variant of the original result of Erdős and Pósa in [11] implies that the class $\mathcal{I}(\theta_2)$ has the v-E&P property (and, according to [8], the e-E&P property as well). A natural question is whether this can be extended for $\mathcal{I}(H)$, for other H 's, different than θ_2 . This is the question that we consider in this paper. A distinct line of research is to identify the graph classes \mathcal{G} such that for every graph H , $\mathcal{I}(H)$ has the e-E&P property

for \mathcal{G} . In this direction, it was recently proved in [20] that for every graph H , $\mathcal{I}(H)$ has the e-E&P property for 4-edge-connected graphs.

In this paper we show that if H is non-trivial (i.e., has at least one edge), connected, planar, and subcubic, i.e., each vertex is incident with at most 3 edges, then $\mathcal{I}(H)$ has the v/e-E&P property (with polynomial gap in both cases). More concretely, our main result is the following.

Theorem 1. *Let H be a connected planar subcubic graph of $h > 0$ edges, let $k \in \mathbb{N}$, and let G be a graph without any $\mathcal{I}(H)$ -vertex/edge packing of size greater than k . Then G has a $\mathcal{I}(H)$ -vertex/edge cover of size bounded by a polynomial function of h and k .*

The main tools of our proof are the graph invariants of tree-cut width and tree-partition width, defined in [28] and [10] respectively (see Section 2 for the formal definitions). Our proof uses the fact that every graph of polynomially (on k) big tree-cut width contains a wall of height k as an immersion (as proved in [28]). This permits us to consider only graphs of bounded tree-cut width and, by applying suitable reductions, we finally reduce the problem to graphs of bounded tree-partition width (Theorem 2). The result follows as we next prove that for every H , the class $\mathcal{I}(H)$ has the e-E&P property for graphs of bounded tree-partition width (Theorem 3).

One might conjecture that the result in Theorem 1 is tight in the sense that both being planar and subcubic are necessary for H in order $\mathcal{I}(H)$ to have the e-E&P property. In this direction, in Section 7, we give counterexamples for the cases where H is planar but not subcubic and is subcubic but not planar.

2 Definitions and preliminary results

We use \mathbb{N}^+ for the set of all positive integers and we set $\mathbb{N} = \mathbb{N}^+ \cup \{0\}$. Given a function $f : A \rightarrow B$ and a set $C \subseteq A$, we denote by $f|_C = \{(x, f(x)) \mid x \in C\}$.

Graphs. As already mentioned, we deal with loopless graphs where multiedges are allowed. Given a graph G , we denote by $V(G)$ its set of vertices and by $E(G)$ its multiset of edges. The notation $|E(G)|$ stands for the total number of edges, that is, counting multiplicities. We use the term *multiedge* to refer to a 2-element set of adjacent vertices and the term *edge* to deal with one particular instantiation of the multiedge connecting two vertices. The function mult_G maps a set of two vertices of G to the multiplicity of the edge

connecting them, or zero if they are not adjacent. If $\text{mult}_G(\{u, v\}) = k$ for some $k \in \mathbb{N}^+$, we denote by $\{u, v\}_1, \dots, \{u, v\}_k$ the distinct edges connecting u and v . For the sake of clarity, we identify a multiedge of multiplicity one and its edge and write $\{u, v\}$ instead of $\{u, v\}_1$ when $\text{mult}_G(\{u, v\}) = 1$.

For $X \subseteq V(G)$, we denote by $G \setminus X$ the graph obtained by removing X and all edges incident to a vertex in X , and for $x \in V(G)$, we simply use $G \setminus x$ to refer to $G \setminus \{x\}$. Similarly, for $F \subseteq E(G)$, we denote by $G \setminus F$ the graph obtained by removing edges in F , and for $e \in E(G)$, we simply use $G \setminus e$ to refer to $G \setminus \{e\}$.

We denote by $\deg_G(v)$ the degree of a vertex v in a graph G , that is, the number of vertices that are adjacent to v . The multidegree of v , that we write $\text{mdeg}_G(v)$, is the number of edges (i.e. counting multiplicities) incident with v . We drop the subscript when it is clear from the context. We also set $\text{m}\delta(G) = \min_{v \in V(G)} \text{mdeg}_G(v)$. We say that a graph G is *subcubic* whenever $\text{mdeg}_G(v) \leq 3$ for every $v \in V(G)$. Two paths are *internally disjoint* if they do not share internal vertices.

Immersion. Let H and G be graphs. We say that G contains H as an *immersion* if there is a pair of functions (ϕ, ψ) , called an *H-immersion model*, such that ϕ is an injection of $V(H) \rightarrow V(G)$ and ψ sends $\{u, v\}_i$ to a path of G between $\phi(u)$ and $\phi(v)$, for every $\{u, v\} \in E(H)$ and every $i \in \{1, \dots, \text{mult}_H(\{u, v\})\}$, in a way such that distinct edges are sent to edge-disjoint paths. This definition of immersions correspond to what is sometimes called weak immersions. Every vertex in the image of ϕ is called a *branch vertex*. We will make use of the following easy observation.

Observation 1. *Let H and G be two graphs, and let (ϕ, ψ) be an H -immersion model in G . Then for every vertex x of G , we have $\text{mdeg}_H(x) \leq \text{mdeg}_G(\phi(x))$.*

An *H-immersion expansion* M in a graph G is a subgraph of G defined as follows: $V(M) = \phi(V(H)) \cup \bigcup_{e \in E(H)} V(\psi(e))$ and $E(M) = \bigcup_{e \in H} E(\psi(e))$ for some H -immersion model (ϕ, ψ) of G . We call the paths in $\psi(E(H))$ *certifying paths* of the H -immersion expansion M .

We say that two edges are *incident* if they share some endpoint. A *lift* of two incident edges $e_1 = \{x, y\}$ and $e_2 = \{y, z\}$ of G is the operation that removes the edges e_1 and e_2 from the graph and then, if $x \neq z$, adds the edge $\{x, z\}$ (or increases the multiplicity of $\{x, z\}$ if this edge already exists). Notice that H is an immersion of G if and only if a graph isomorphic to H can be obtained from some subgraph of G after applying lifts of incident

edges¹.

The *dissolution* of a vertex of degree two of a graph is the operation of adding an edge joining its endpoints and then deleting this vertex.

Packings and coverings. An H -cover of G is a set $C \subseteq E(G)$ such that $G \setminus C$ does not contain H as an immersion. An H -packing in G is a collection of edge-disjoint H -immersion expansions in G . We denote by $\mathbf{pack}_H(G)$ the maximum size of an H -packing and by $\mathbf{cover}_H(G)$ the minimum size of an H -cover in G .

Rooted trees. A *rooted tree* is a pair (T, s) where T is a tree and $s \in V(T)$ is a vertex referred to as the *root*. Given a vertex $x \in V(T)$, the *descendants* of x in (T, s) , denoted by $\text{desc}_{(T,s)}(x)$, is the set containing each vertex w such that the unique path from w to s in T contains x . If y is a descendant of x and is adjacent to x , then it is a *child* of x . Two vertices of T are *siblings* if they are children of the same vertex. Given a rooted tree (T, s) and a vertex $x \in V(G)$, the *height* of x in (T, s) is the maximum distance between x and a vertex in $\text{desc}_{(T,s)}(x)$.

We now define two types of decompositions of graphs: tree-partitions (cf. [15, 26]) and tree-cut decompositions (cf. [28]).

Tree-partitions. We introduce, especially for the needs of our proof, a multigraph extension of the parameter of tree-partition width defined in [15, 26] where we could consider the number of edges between the bags and the number of vertices in the bags. A *tree-partition* of a graph G is a pair $\mathcal{D} = (T, \mathcal{X})$ where T is a tree and $\mathcal{X} = \{X_t\}_{t \in V(T)}$ is a partition of $V(G)$ such that either $|V(T)| = 1$ or for every $\{x, y\} \in E(G)$, there exists an edge $\{t, t'\} \in E(T)$ where $\{x, y\} \subseteq X_t \cup X_{t'}$. We call the elements of \mathcal{X} *bags* of \mathcal{D} . Given an edge $f = \{t, t'\} \in E(T)$, we define E_f as the set of edges with one endpoint in X_t and the other in $X_{t'}$. The *width* of \mathcal{D} is defined as $\max\{|X_t|_{t \in V(T)} \cup \{|E_f|_{f \in E(T)}\}$. The *tree-partition width* of G is the minimum width over all tree-partitions of G and will be denoted by $\mathbf{tpw}(G)$. A *rooted tree-partition* of a graph G is a triple $\mathcal{D} = ((T, s), \mathcal{X})$ where (T, s) is a rooted tree and (\mathcal{X}, T) is a tree-partition of G .

¹While we mentioned this definition in the introduction, in the rest of the paper, we adopt the more technical definition of immersion in terms of immersion models as this will facilitate the presentation of the proofs.

Tree-cut decompositions. A *near-partition* of a set S is a collection of pairwise disjoint subsets $S_1, \dots, S_k \subseteq S$ (for some $k \in \mathbb{N}$) such that $\bigcup_{i=1}^k S_i = S$. Observe that this definition allows a set S_i of the family to be empty. A *tree-cut decomposition* of a graph G is a pair $\mathcal{D} = (T, \mathcal{X})$ where T is a tree and $\mathcal{X} = \{X_t\}_{t \in V(T)}$ is a near-partition of $V(G)$. As in the case of tree-partitions, we call the elements of \mathcal{X} *bags* of \mathcal{D} . A *rooted tree-cut decomposition* of a graph G is a triple $\mathcal{D} = ((T, s), \mathcal{X})$ where (T, s) is a rooted tree and (T, \mathcal{X}) is a tree-cut decomposition of G . Given that $\mathcal{D} = ((T, s), \mathcal{X})$ is a rooted tree-partition or a rooted tree-cut decomposition of G and given $t \in V(T)$, we set $G_t = G \left[\bigcup_{t \in \text{desc}_{(T,s)}(t)} X_t \right]$.

The *torso* of a tree-cut decomposition (T, \mathcal{X}) at a node t is the graph obtained from G as follows. If $V(T) = \{t\}$, then the torso at t is G . Otherwise let T_1, \dots, T_ℓ be the connected components of $T \setminus t$. The torso H_t at t is obtained from G by *consolidating* each vertex set $\bigcup_{b \in V(T_i)} X_b$ into a single vertex z_i . The operation of consolidating a vertex set Z into z is to replace Z with z in G , and for each edge e between Z and $v \in V(G) \setminus Z$, adding an edge $\{z, v\}$ in the new graph. Given a graph G and $X \subseteq V(G)$, let the β -*center* of (G, X) be the unique graph obtained from G by suppressing vertices in $V(G) \setminus X$ of degree two and deleting vertices of degree at most 1. For each node t of T , we denote by \widetilde{H}_t the β -*center* of (H_t, X_t) , where H_t is the torso of (T, \mathcal{X}) at t .

Let $\mathcal{D} = ((T, s), \mathcal{X})$ be a rooted tree-cut decomposition of G . The adhesion of a vertex t of T , that we write $\text{adh}_{\mathcal{D}}(t)$, is the number of edges with exactly one endpoint in G_t . The *width* of a tree-cut decomposition (\mathcal{X}, T) of G is $\max_{t \in V(T)} \{\text{adh}_{\mathcal{D}}(t), |\widetilde{H}_t|\}$. The *tree-cut width* of G , denoted by $\text{tcw}(G)$, is the minimum width over all tree-cut decompositions of G .

A vertex $t \in V(T)$ is *thin* if $\text{adh}_{\mathcal{D}}(t) \leq 2$, and *bold* otherwise. We also say that \mathcal{D} is *nice* if for every thin vertex $t \in V(T)$ we have $N(V(G_t)) \cap \bigcup_{b \text{ is a sibling of } t} V(G_b) = \emptyset$. In other words, there is no edge from a vertex of G_t to a vertex of G_b , for any sibling b of t , whenever t is thin. The notion of nice tree-cut decompositions has been introduced by Ganian et al. in [13]. Furthermore, they proved the following result.

Proposition 1 ([13]). *Every rooted tree-cut decomposition can be transformed into a nice one without increasing the width.*

We say that an edge of G *crosses* the bag X_t , for some $t \in V(T)$ if its endpoints belong to bags X_{t_1} and X_{t_2} , for some $t_1, t_2 \in V(T)$ such that t belongs to the interior of the (unique) path of T connecting t_1 to t_2 .

3 From tree-cut decompositions to tree-partitions

The purpose of this section is to prove the following theorem.

Theorem 2. *For every connected graph G , and every connected graph H with at least one edge, there is a graph G' such that*

- $\text{tpw}(G') \leq (\text{tcw}(G) + 1)^2/2$,
- $\text{pack}_{H^+}(G') \leq \text{pack}_H(G)$, and
- $\text{cover}_H(G) \leq \text{cover}_{H^+}(G')$.

Theorem 2 will allow us in **Section 4** to consider graphs of bounded tree-partition width instead of graphs of bounded tree-cut width. Before we proceed with the proof of **Theorem 2**, we need some definitions and a series of auxiliary results.

For every graph G , we define G^+ as the graph obtained if, for every vertex v , we add two new vertices v' and v'' and the edges $\{v', v''\}$ (of multiplicity 2), $\{v, v'\}$ and $\{v, v''\}$ (both of multiplicity 1). Observe that for every connected graph G , we have $\text{m}\delta(G^+) \geq 3$. We also define G^* as the graph obtained by adding, for every vertex v , the new vertices $v'_1, \dots, v'_{\text{mdeg}(v)}$ and $v''_1, \dots, v''_{\text{mdeg}(v)}$ and the edges $\{v'_i, v''_i\}$ (of multiplicity 2), $\{v, v'_i\}$, and $\{v, v''_i\}$ (both of multiplicity 1), for every $i \in \{1, \dots, \text{deg}(v)\}$. If v is a vertex of G , then we denote by $Z_{v,i}$ the subgraph $G^*[\{v, v'_i, v''_i\}]$ for every $i \in \{1, \dots, \text{mdeg}_G(v)\}$.

Our first aim is to prove the following three lemmata.

Lemma 1. *Let G be a graph, let H be a connected graph with at least one edge and let G' be a subdivision of G^* . Then we have*

- $\text{pack}_{H^+}(G^*) = \text{pack}_{H^+}(G')$ and
- $\text{cover}_{H^+}(G^*) = \text{cover}_{H^+}(G')$.

Proof. We denote by S the set of subdivision vertices added during the construction of G' from G^+ . As G' is a subdivision of G^* , we have $\text{pack}_{H^+}(G') \geq \text{pack}_{H^+}(G^*)$ and $\text{cover}_{H^+}(G') \geq \text{cover}_{H^+}(G^*)$.

As a consequence of **Observation 1** and the fact that $\text{m}\delta(H^+) \geq 3$, if M is an H^+ -immersion expansion in G' then no branch vertex of M belongs to S . Indeed, every vertex of S has multidegree 2 in G' . Therefore, by

dissolving in M the vertices of S that belong to $V(M)$, we obtain an H^+ -immersion expansion in G^* . It follows that $\mathbf{pack}_{H^+}(G^*) \geq \mathbf{pack}_{H^+}(G')$, hence $\mathbf{pack}_{H^+}(G^*) = \mathbf{pack}_{H^+}(G')$.

On the other hand, let X be an H^+ -cover of G^* and let X' be a set of edges constructed by taking, for every $e \in X$, an edge of the path of G' connecting the endpoints of e that has been created by subdividing e . Assume that X' is not an H^+ -cover of G' . According to the remark above, this implies that X is not an H^+ -cover of G^* , a contradiction. Hence X' is an H^+ -cover of G' and thus $\mathbf{cover}_{H^+}(G^*) = \mathbf{cover}_{H^+}(G')$. \square

Lemma 2. *For every two graphs H and G such that H is connected and has at least one edge, we have $\mathbf{pack}_{H^+}(G^*) \leq \mathbf{pack}_H(G)$.*

Proof. In G^* (respectively H^+), we say that a vertex is *original* if it belongs to $V(G)$ (respectively $V(H)$). Let (ϕ, ψ) be an H^+ -immersion model in G^* .

We first show that if u is an original vertex of H^+ , then $\phi(u)$ is an original vertex of G^* . By contradiction, let us assume that $\phi(u)$ is not original, for some original vertex u of H^+ . Then $\phi(u) = v'_i$ or $\phi(u) = v''_i$, for some $v \in V(G)$ and $i \in \{1, \dots, \text{mdeg}_G(v)\}$.

Observe that since H is connected and has at least one edge, every vertex of H^+ has degree at least three: let x , y , and z be the endpoints of three multiedges incident with u . Then $\psi(\{u, x\})$, $\psi(\{u, y\})$, and $\psi(\{u, z\})$ are edge-disjoint paths connecting $\phi(u)$ to three distinct vertices. This is not possible because there is an edge cut of size two, $\{\{v, v'_i\}, \{v, v''_i\}\}$, separating the two vertices v'_i and v''_i (among which is $\phi(u)$) from the rest of the graph. Consequently, if $u \in V(H^+)$ is original, then $\phi(u)$ is original.

Let us now consider an edge $\{u, v\} \in E(H)$. By the above remark, $\phi(u)$ and $\phi(v)$ are original vertices of G^* . It is easy to see that $\psi(\{u, v\})$ contains only original vertices of G^* . Indeed, if this path contained a non-original vertex w' or w'' for some original vertex w of $V(G^*)$, it would use w twice in order to reach u and v , what is not allowed. Therefore, from the definition of H^+ , the pair $(\phi|_{V(H)}, \psi|_{E(H)})$ is an H -immersion model of G .

We proved that every H^+ -immersion-expansion of G^* contains an H -immersion-expansion that belongs to the subgraph G of G^* . Consequently every H^+ -packing of G^* contains an H -packing of the same size that belongs to G , and the desired inequality follows. \square

Lemma 3. *For every two graphs H and G such that H is connected and has at least one edge, we have $\mathbf{cover}_H(G) \leq \mathbf{cover}_{H^+}(G^*)$.*

Proof. Similarly to the proof of [Lemma 2](#), we say that an edge of G^* is *original* if it belongs to $E(G)$. Let $X \subseteq E(G^*)$ be a minimum cover of H^+ -immersion expansions in G^* .

First case: all the edges in X are original. In this case, X is an H -cover of G as well. Indeed, if $G \setminus X$ contains an H -immersion expansion M , then $G^* \setminus X$ contains M^* that, in turn, contains H^+ . Hence in this case, $\mathbf{cover}_H(G) \leq \mathbf{cover}_{H^+}(G^*)$.

Second case: there is an edge $e \in X$ that is not original. Let v be the original vertex of G^* such that either $e \in Z_{v,l}$ for some $l \in \{1, \dots, \text{mdeg}_G(v)\}$. Let us first show the following claim.

Claim: For every $i \in \{1, \dots, \text{mdeg}_G(v)\}$, there is an edge of $Z_{v,i}$ that belongs to X .

Proof of claim: Looking for a contradiction, let us assume that we have $E(Z_{v,i}) \cap X = \emptyset$, for some $i \in \{1, \dots, \text{mdeg}_G(v)\}$. Clearly $i \neq l$. By minimality of X , the graph $G \setminus (X \setminus \{e\})$ contains an H^+ -immersion expansion M that uses e . Observe that $M' = M \setminus E(Z_{v,l}) \cup E(Z_{v,i})$ contains an H^+ -immersion expansion (since $Z_{v,l}$ and $Z_{v,i}$ are isomorphic). Hence, M' is a subgraph of $G \setminus (X \setminus \{e\})$ that contains an H^+ -immersion expansion. This is not possible as X is a cover, so we reach the contradiction we were looking for and the claim holds. \diamond

We build a set Y as follows. For every edge $f \in X$, if f is original then we add to Y . Otherwise, if v_f is the (original) vertex of G^* such that $e \in E(Z_{v_f,i})$ for some $i \in \{1, \dots, \text{mdeg}_G(v_f)\}$, then we add to Y all edges that are incident to v_f .

The above claim ensures that when a non-original edge f of X is encountered, then X contains an edge in each of $Z_{v_f,1}, \dots, Z_{v_f,\text{mdeg}_G(v_f)}$. Therefore, the same set of edges, of size $\text{mdeg}_G(v_f)$, will be added to Y when encountering an other edge from $Z_{v_f,1}, \dots, Z_{v_f,\text{mdeg}_G(v_f)}$. Consequently, $|X| = |Y|$.

Let us not show that Y is an H^+ -cover of G^* . Suppose that there exists an H^+ -immersion expansion M in $G^* \setminus Y$. Observe that since H is connected and has at least one edge, M does not belong to $\bigcup_{i \in \{1, \dots, \text{mdeg}_G(u)\}} Z_{u,i}$, for every original vertex u of G^* . Let

$$Z = \bigcup_{u \in V(G)} \bigcup_{i \in \{1, \dots, \text{mdeg}_G(u)\}} E(Z_{u,i})$$

Then M is a subgraph of $G \setminus (Y \cup Z)$. As $X \subseteq Y \cup Z$, this contradicts the fact that X is a cover. Therefore, Y is an H^+ -cover. Moreover all the edges in Y are original. As this situation is treated by the first case above, we are done. \square

We are now ready to prove [Theorem 2](#).

of [Theorem 2](#). Let $k = \mathbf{tcw}(G)$. We examine the nontrivial case where G is not a tree, i.e., $\mathbf{tcw}(G) \geq 2$. Let us consider the graph G^* . We claim that $\mathbf{tcw}(G^*) = \mathbf{tcw}(G)$. Indeed, starting from an optimal tree-cut decomposition of G , we can, for every vertex v of G and for every $i \in \{1, \dots, \text{mdeg}_G(v)\}$, create a bag that is a children of the one of v and contains $\{v'_i, v''_i\}$. According to the definition of G^* , this creates a tree-cut decomposition $\mathcal{D} = ((T, s), \{X_t\}_{t \in V(T)})$ of G^* . Observe that for every vertex x that we introduced to the tree of the decomposition during this process, $\text{adh}_{\mathcal{D}}(x) = 2$ and the corresponding bag has size two. This proves that $\mathbf{tcw}(G^*) \leq \max(\mathbf{tcw}(G), 2) = \mathbf{tcw}(G)$. As G is a subgraph of G^* , we obtain $\mathbf{tcw}(G) \leq \mathbf{tcw}(G^*)$ and the proof of the claim is complete.

According to [Proposition 1](#), we can assume that G^* has a nice rooted tree-cut decomposition of width $\leq k$. For notational simplicity we again denote it by $\mathcal{D} = ((T, s), \{X_t\}_{t \in V(T)})$ and, obviously, we can also assume that all leaves of T correspond to non-empty bags.

Our next step is to transform the rooted tree-cut decomposition \mathcal{D} into a rooted tree-partition $\mathcal{D}' = ((T, s), \{X'_t\}_{t \in V(T)})$ of a subdivision G' of G^* . Notice that the only differences between two decompositions are that, in a tree-cut decomposition, empty bags are allowed as well as edges connecting vertices of bags corresponding to non-adjacent vertices of T .

We proceed as follows: if X is a bag crossed by edges, we subdivide every edge crossing X and add the obtained subdivision vertex to X . By repeating this process we decrease at each step the number of bags crossed by edges, that eventually reaches zero. Let G' be the obtained graph and observe that G' is a subdivision of G . As G is connected, the obtained rooted tree-cut decomposition $\mathcal{D}' = ((T, s), \{X'_t\}_{t \in V(T)})$ is a rooted tree partition of G' .

Notice that the adhesion of any bag of T in \mathcal{D} is the same as in \mathcal{D}' . However, the bags of \mathcal{D}' may grow during the construction of G' . Let t be a vertex of T and let $\{t_1, \dots, t_m\}$ be the set of children of t . We claim that $|X'_t| \leq (k+1)^2/2$.

Let E_t be the set of edges crossing X_t in G . Let H_t be the torso of \mathcal{D} at t , and let $H'_t = H_t \setminus X_t$. Observe that $|E_t|$ is the same as the number of edges in H'_t . Let z_p be the vertex of H'_t corresponding to the parent of t , and similarly for each $i \in \{1, \dots, m\}$ let z_i be the vertex of H'_t corresponding to the child t_i of t . Notice that if t_i is a thin child of t , then z_i can be adjacent to only z_p as \mathcal{D} is a nice rooted tree-cut decomposition. Thus the sum of the number of incident edges with z_i in H'_t for all thin children t_i of t is at most $\text{adh}_{\mathcal{D}}(t) \leq k$. On the other hand, if t_i is a bold child of t , then z_i

has at least 3 neighbors in H_t , and thus it is contained in the 3-center of (H_t, X_t) . Thus, the number of all bold children of t is bounded by $k - |X_t|$. Since each vertex in H'_t is incident with at most k edges, the total number of edges in H'_t is at most $(k - |X_t| + 1)k/2 + k$. As $|E(H'_t)| = |E_t| = |X'_t \setminus X_t|$, it implies that $|X'_t| \leq |X_t| + k \cdot (k - |X_t| + 2)/2 \leq \max\{2k, k(k + 2)/2\} \leq (k + 1)^2/2$. We conclude that G' has a rooted tree-partition of width at most $(\text{tcw}(G) + 1)^2/2$.

Recall that G' is a subdivision of G^* . By the virtue of [Lemma 3](#), [Lemma 2](#), and [Lemma 1](#), we obtain that $\text{pack}_{H^+}(G') \leq \text{pack}_H(G)$ and $\text{cover}_H(G) \leq \text{cover}_{H^+}(G')$. Hence G' satisfies the desired properties. \square

4 Erdős–Pósa in graphs of bounded tree-partition width

Before we proceed, we require the following lemma and an easy observation.

Lemma 4. *Let G and H be two graphs such that H has no isolated vertices and let $X \subseteq V(G)$. Let \mathcal{C} be the collection of connected components of $G \setminus X$. If M is an H -immersion expansion of G then M contains vertices from at most $(|X| + 1) \cdot |E(H)|$ graphs of \mathcal{C} .*

Proof. Let P be a certifying path of M connecting two branch vertices of M . Since P is a path, it cannot use twice the same vertex of X . Besides, as X is a separator, P must go through a vertex of X in order to go from one graph of \mathcal{C} to an other one. Therefore, P contains vertices from at most $|X| + 1$ graphs of \mathcal{C} . The desired bound follows as $E(M)$ is partitioned into $|E(H)|$ certifying paths. \square

Observation 2. *Let G and H be graphs and let $F \subseteq E(G)$. Then it holds that $\text{cover}_H(G) \leq \text{cover}_H(G \setminus F) + |F|$.*

For a graph H , we define $\omega_H : \mathbb{N} \rightarrow \mathbb{N}$ so that $\omega_H(r) = \lceil r \cdot \frac{3r+1}{2} \cdot |E(H)| \rceil$. The next theorem is an important ingredient of our results.

Theorem 3. *Let H be a connected graph with at least one edge. Then for every graph G it holds that $\text{cover}_H(G) \leq \omega_H(\text{tpw}(G)) \cdot \text{pack}_H(G)$*

Proof. Let us show by induction on k that if $\text{pack}_H(G) \leq k$ and $\text{tpw}(G) \leq r$ then $\text{cover}_H(G) \leq \omega_H(r) \cdot k$.

The case $k = 0$ is trivial. Let us now assume that $k \geq 1$ and that for every graph G of tree-partition width at most r and such that $\text{pack}_H(G) =$

$k - 1$, we have $\mathbf{cover}_H(G) \leq \omega_H(r)(k - 1)$. Let G be a graph such that $\mathbf{pack}_H(G) = k$ and $\mathbf{tpw}(G) \leq r$. Let also $\mathcal{D} = ((T, s), \{X_t\}_{t \in V(T)})$ be an optimal rooted tree-partition of G . We say that a vertex $t \in V(T)$ is *infected* if G_t contains an H -immersion expansion. Recall that the height of a vertex in a rooted tree is the maximum distance to a descendant. Let t be an infected vertex of T of minimum height.

Claim: If some of the H -immersion expansions of G shares a vertex with $G_{t'}$ for some child t' of t , then it also shares an edge with $E_{\{t, t'\}}$.

Proof of claim: Let M be some H -immersion expansions of G . Notice that, by the choice of t , M cannot be entirely inside $G_{t'}$. This fact, together with the connectivity of M , implies that $E(M) \cap E_{\{t, t'\}} \neq \emptyset$. \diamond

Suppose that M is an H -immersion expansion of G_t and let U be the set of children of t corresponding to bags which share vertices with M . We define the multisets $A = E(G[X_t]) \cap E(M)$, $B = \bigcup_{t' \in U} E_{\{t, t'\}}$ and $C = \bigcup_{t' \in U} E(G_{t'})$. We also set $D = A \cup B$. By the definition of U , it follows that $E(M) \subseteq C \cup D$ **(1)**.

Let us upper-bound the size of $|D|$. Applying **Lemma 4** for G_t , H , and X_t , we have $|U| \leq (r + 1) \cdot |E(H)|$, hence $|B| \leq r(r + 1) \cdot |E(H)|$. Besides, every path of M connecting two branch vertices meets every vertex of X_t at most once (as it is a path), thus $E(M)$ does not contain an edge of $G[X_t]$ with a multiplicity larger than $|E(H)|$. It follows that $|A| \leq \frac{r(r-1)}{2} \cdot |E(H)|$ and finally we obtain that $|D| = |A| + |B| \leq r \cdot \frac{3r+1}{2} \cdot |E(H)| = \omega_H(r)$.

Let $G' = G \setminus D$. We now show that $\mathbf{pack}_H(G') \leq k - 1$. Let us consider an H -immersion expansion M' in G' . As $E(M') \subseteq E(G) \setminus D$, it follows that $E(M') \cap D = \emptyset$. **(2)**

Recall that $B \subseteq D$, which together with **(2)** implies that $E(M') \cap B = \emptyset$. This fact, combined with the claim above, implies that $E(M') \cap C = \emptyset$. **(3)** From **(2)** and **(3)**, we obtain that $E(M') \cap (C \cup D) = \emptyset$, which, combined with **(1)**, implies that $E(M) \cap E(M') \neq \emptyset$. Consequently, every maximum packing of H -immersion expansions in G' is edge-disjoint from M . If such a packing had size $\geq k$, it would form together with M a packing of size $k + 1$ in G , a contradiction. Thus $\mathbf{pack}_H(G') \leq k - 1$, as desired. By the induction hypothesis applied on G' , $\mathbf{cover}_H(G') \leq \omega_H(r) \cdot (k - 1)$ edges. Therefore, from **Observation 2**, $\mathbf{cover}_H(G) \leq |D| + \mathbf{cover}_H(G') \leq |D| + \omega_H(r) \cdot (k - 1) \leq \omega_H(r) \cdot k$ edges as required. \square

We set $\sigma : \mathbb{N} \rightarrow \mathbb{N}$ where $\sigma(r) = \lceil \frac{1}{8}(3(r + 1)^4 + 2(r + 1)^2) \rceil$.

Theorem 4. *Let H be a connected graph with at least one edge, $r \in \mathbb{N}$, and G be a graph where $\mathbf{tcw}(G) \leq r$. Then $\mathbf{cover}_H(G) \leq \sigma(r) \cdot (4 \cdot |V(H)| +$*

$|E(H)| \cdot \mathbf{pack}_H(G)$.

Proof. Clearly, we can assume that G is connected, otherwise we work on each of its connected components separately. By [Theorem 2](#), there is a graph G' where $\mathbf{tpw}(G') \leq (r + 1)^2/2$, $\mathbf{pack}_{H^+}(G') \leq \mathbf{pack}_H(G)$ and $\mathbf{cover}_H(G) \leq \mathbf{cover}_{H^+}(G')$. The result follows as, from [Theorem 3](#), $\mathbf{cover}_{H^+}(G') \leq \omega_{H^+}((r + 1)^2/2) \cdot \mathbf{pack}_{H^+}(G')$ and $\omega_{H^+}((r + 1)^2/2) = \sigma(r) \cdot |E(H^+)| \leq \sigma(r) \cdot (4 \cdot |V(H)| + |E(H)|)$. \square

5 Erdős–Pósa for immersions of subcubic planar graphs

Grids and Walls. Let k and r be positive integers where $k, r \geq 2$. The $(k \times r)$ -grid $\Gamma_{k,r}$ is the Cartesian product of two paths of lengths $k - 1$ and $r - 1$ respectively. We denote by Γ_k the $(k \times k)$ -grid. The k -wall W_k (also called wall of *height* k) is the graph obtained from a $((k + 1) \times (2k + 2))$ -grid with vertices (x, y) , $x \in \{1, \dots, k + 1\}$, $y \in \{1, \dots, 2k + 2\}$, after the removal of the “vertical” edges $\{(x, y), (x + 1, y)\}$ for odd $x + y$, and then the removal of all vertices of degree 1.

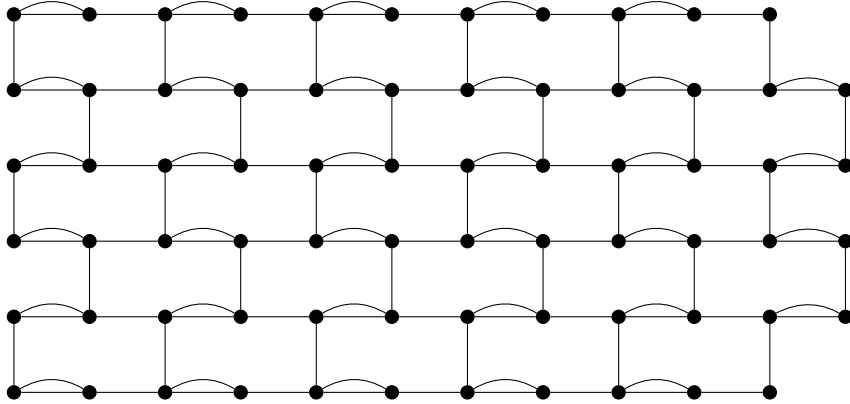

Figure 1: The graph \widehat{W}_5 .

Let W_k be a wall. We denote by $P_j^{(v)}$ the shortest path connecting vertices $(1, 2j)$ and $(k + 1, 2j)$, $j \in [k]$ and call these paths the *vertical paths* of W_k , with the assumption that $P_j^{(v)}$ contains only vertices (x, y) with $y = 2j, 2j - 1$. Note that these paths are vertex-disjoint. Similarly, for every $i \in [k + 1]$ we denote by $P_i^{(h)}$ the shortest path connecting vertices $(i, 1)$

and $(i, 2k + 2)$ (or $(i, 2k + 1)$ if $(i, 2k + 2)$ has been removed) and call these paths the *horizontal paths* of W_k . Let $E = \{e \mid e \in E(P_j^{(v)}) \cap E(P_i^{(h)}), j \in \{1, 2, \dots, k\}, i \in \{1, 2, \dots, k + 1\}\}$. We obtain \widehat{W}_k from W_k by adding a second copy of every edge in E (cf. [Figure 1](#)).

Strong immersions. If we additionally require in the definition of the immersion containment that no branch vertex is an internal vertex of any certifying path, then the function (ϕ, ψ) is an *H-strong-immersion model*. We then say that G contains H as a *strong immersion*, what we denote by $H \leq_{\text{sim}} G$.

Topological minors. If we additionally require in the definition of the immersion containment that certifying paths are pairwise internally disjoint, then (ϕ, ψ) is an *H-topological model*. We then say that G contains H as a *topological minor*, what we denote by $H \leq_{\text{tm}} G$.

Observe that in a graph, every topological minor is a strong immersion of G , and every strong immersion is an immersion. The expansion of a strong immersion or topological model is defined as the one of an immersion model.

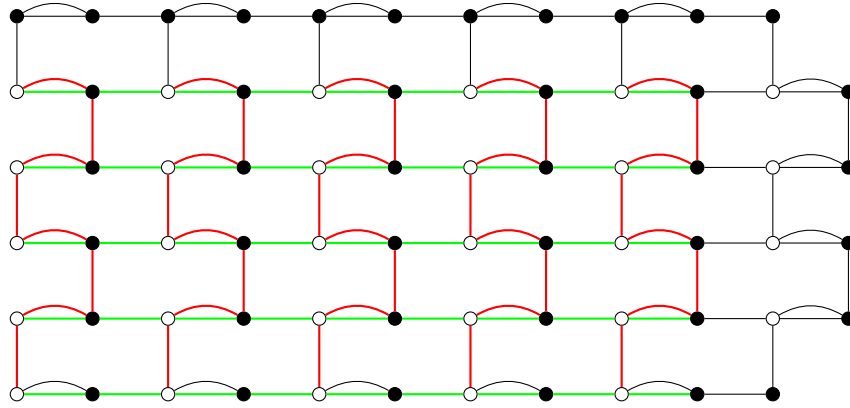

Figure 2: Finding Γ_5 as a strong immersion in \widehat{W}_5 .

The next observation is a formal statement of what is depicted on [Figure 2](#): \widehat{W}_n contains Γ_n as a strong immersion. Branch vertices are depicted by white nodes and horizontal (respectively vertical) paths use the color green (respectively red).

Observation 3. Let $k \geq 2$ be an integer. If we define ϕ and ψ with domains $V(\Gamma_n)$ and $E(\Gamma_n)$, respectively, as follows:

$$\begin{aligned}\phi((i, j)) &= (i, 2j - 1) \\ \psi(\{(i, j), (i, j + 1)\}) &= (i, 2j - 1)(i, 2j)(i, 2(j + 1) - 1) \\ \psi(\{(i, j), (i + 1, j)\}) &= (i, 2j - 1)(i + 1, 2j - 1) \text{ for odd } i \\ \psi(\{(i, j), (i + 1, j)\}) &= (i, 2j - 1)(i, 2j)(i + 1, 2j)(i + 1, 2j - 1) \text{ for even } i,\end{aligned}$$

then (ϕ, ψ) is a Γ_k -strong-immersion model in \widehat{W}_k (where we assume that Γ_k has vertex set $\{1, \dots, k\}^2$).

We also need the following result.

Lemma 5 ([17]). Every simple planar subcubic graph of n vertices is a topological minor of the $\lfloor \frac{n}{2} \rfloor$ -grid.

The next result is mentioned in [27] but no proof is provided.

Lemma 6. Every planar subcubic graph on n -vertices is a strong immersion of the wall W_n .

Proof. Let H be a graph on n vertices. The proof goes as follows: we first construct a topological expansion H' of H that is a simple graph. Then we prove that H' is a strong-immersion of \widehat{W}_n and obtain the following ordering:

$$H \leq_{\text{tm}} H' \leq_{\text{tm}} \Gamma_n \leq_{\text{sim}} \widehat{W}_n. \quad (1)$$

Finally, we construct a topological model of H' in \widehat{W}_n . The expansion of this model is simple, hence it will be a subgraph of W_n , as required.

Let H be a planar subcubic graph and let H' be the simple subcubic planar graph obtained from H by subdividing all but one edges of every multiedge. Notice that the first inequality of equation (1) is satisfied. Let us count how many vertices are added during the construction of H' . As H is subcubic, among the edges incident to a given vertex, at most two are being subdivided. That way we count each subdivided edge twice (once for each of its endpoints), hence we get:

$$|V(H')| \leq 2|V(H)|.$$

According to Lemma 5, H' is a topological minor of Γ_n : this gives the second inequality of the equation. Observation 3 gives the third inequality.

Let (ϕ_1, ψ_1) be an H' -topological model in Γ_n and let (ϕ_2, ψ_2) be the Γ_n -strong-immersion model in \widehat{W}_n given by Observation 3. These two models

can be used to construct an H' -strong immersion model (ϕ, ψ) in \widehat{W}_n , as the composition of (ϕ_1, ψ_1) and (ϕ_2, ψ_2) : for every $v \in V(H')$, $\phi(v) = \phi_2(\phi_1(v))$ and for every $e \in E(H')$, $\psi(e)$ is the concatenation of the paths obtained by applying ψ_2 to the edges of the path $\psi_1(e)$ (taken in the same order as they appear in this path). Observe that this model satisfies the following properties:

- the expansion of (ϕ, ψ) is a subgraph of the expansion of (ϕ_2, ψ_2) ; and
- the branch vertices of (ϕ, ψ) are branch vertices of (ϕ_2, ψ_2) .

We provide the following diagram to recall the roles of the different models we use (topological models are indicated by double arrows and strong immersion models by simple ones).

$$\begin{array}{ccc}
 H' & \xrightarrow{(\phi_1, \psi_1)} & \Gamma_n \\
 & \searrow (\phi, \psi) & \downarrow (\phi_2, \psi_2) \\
 & & \widehat{W}_n
 \end{array}$$

Let us show the following claim.

Claim 1. *Let $e, f \in E(H')$. If v is an internal vertex of both $\psi(e)$ and $\psi(f)$, then these paths also share an endpoint, which is adjacent to v .*

If $\psi(e)$ and $\psi(f)$ share an internal vertex v , there are two edges $a \in \psi_1(e)$ and $b \in \psi_1(f)$ such that both $\psi_2(a)$ and $\psi_2(b)$ contain v . By definition of (ϕ_2, ψ_2) , such a situation occurs only if $a = \{(i, j), (i + 1, j)\}$ (for even i) and $b = \{(i, j), (i, j + 1)\}$ or $b = \{(i + 1, j), (i + 1, j + 1)\}$, for some even $i \in \{1, \dots, n\}$ and some $j \in \{1, \dots, n\}$ (see [Figure 2](#)). Observe that in both cases a and b share an endpoint. As (ϕ_1, ψ_1) is a topological minor model, $\psi_1(e)$ and $\psi_1(f)$ may meet on endpoints only. Therefore the common endpoint of a and b is an endpoint of both $\psi_1(e)$ and $\psi_1(f)$, hence $\psi(e)$ and $\psi(f)$ have a common endpoint. This proves the first part of the claim. The second part is now clear from the definition of (ϕ_2, ψ_2) , as we know that the paths $\psi_1(e)$ and $\psi_1(f)$ start from the same vertex, one with a “vertical” edge, the other with a “horizontal” edge (see [Figure 2](#)). \diamond

If (ϕ, ψ) , which is a strong immersion model, is a topological model, then we can directly jump to the next step. Otherwise, according to [Claim 1](#), there are two edges $e = \{u, v\}, f = \{u, w\}$ of H and vertices $x, y \in \widehat{W}_n$ such that $\psi(e)$ and $\psi(f)$ both start with $x = \phi(u)$ followed by y . Hence

$\{x, y\}$ is a double edge of \widehat{W}_n . As (ϕ, ψ) is a strong immersion model of a subcubic graph, x has degree at most three in the expansion of (ϕ, ψ) . We can therefore modify (ϕ, ψ) as follows: we set $\phi(u) = x$ and we shorten $\psi(\{u, v\})$ and $\psi(\{u, w\})$ by removing the edge $\{x, y\}$ from each of them. In the case where there is a third vertex $t \in V(H) \setminus \{v, w\}$ adjacent to u , we also extend the path $\psi(\{t, u\})$ by adding the edge $\{x, y\}$. See [Figure 3](#) for an example.

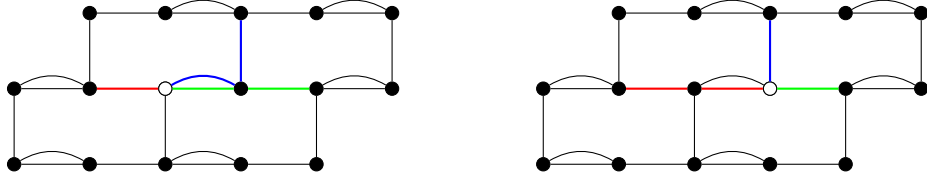

Figure 3: Swapping branch vertices.

It is easy to see that by applying these changes we still get an H' -strong immersion model, with less crossings of certifying paths. By repeatedly applying these steps we eventually obtain a H' -topological model in \widehat{W}_n^+ . Notice that its expansion is a simple graph, as H' is a simple graph. Therefore this expansion is also a subgraph of W_n . We proved that H' is a topological minor of W_n . It follows that the same holds for H and we are done. \square

By combining [\[28, Theorem 17\]](#) with the main result of [\[7\]](#) (see also [\[6\]](#)) we can readily obtain the following.

Theorem 5. *There is a function $\tau : \mathbb{N}^+ \rightarrow \mathbb{N}$ such that the following holds: for every graph G and $r \in \mathbb{N}^+$, if $\mathbf{tcw}(G) \geq f(r)$ then W_r is an immersion of G . Moreover, $f(r) = O(r^{29} \text{polylog}(r))$.*

Lemma 7. *Let G be a graph and let H be a connected planar subcubic graph on h vertices. Then $\mathbf{tcw}(G) = O(h^{29} \cdot (\mathbf{pack}_{\mathcal{I}(H)}(G))^{14.5} \cdot (\text{polylog}(h) + \text{polylog}(\mathbf{pack}_{\mathcal{I}(H)}(G))))$.*

Proof. Let $\mathbf{pack}_H(G) \leq k$. Let $g(h, k) = f((h + 1) \cdot \lceil (k + 1)^{1/2} \rceil)$, where f is the function of [Theorem 5](#). Suppose that $\mathbf{tcw}(G) \geq g(h, k)$. Then, from [Theorem 5](#), we obtain that G contains the wall W of height $(h + 1) \cdot \lceil (k + 1)^{1/2} \rceil$ as an immersion. Notice that W contains $k + 1$ vertex-disjoint walls of height h . From [Lemma 6](#), each one of these walls contains H as an immersion and thus an H -immersion expansion. Since, these walls are vertex-disjoint they are also edge-disjoint. Hence, we have found a packing

of H of size $k + 1 > k$, a contradiction. Therefore, $\text{tcw}(G) \leq g(h, k)$. Notice now that, from [Theorem 5](#), $g(h, k) = O(h^{29}k^{14.5}(\text{polylog}(h) + \text{polylog}(k)))$ as required. \square

The edge version of [Theorem 1](#) follows as a corollary of [Theorem 4](#) and [Lemma 7](#).

6 The vertex case

To prove the vertex version of [Theorem 1](#), is a much easier task. For this, we follow the same methodology by using the graph parameter of treewidth instead of tree-cut width, and topological minors instead of immersions.

Treewidth. A graph H is k -chordal if it does not contain any induced cycle of length at least 4 and no clique one more than $k + 1$ vertices. The *treewidth* of a graph G is the minimum k for which G is a subgraph of a k -chordal graph.

Topological Minors. Let H and G graphs. Similarly to the definition of immersions, we say that G contains H as a *topological minor* if there is pair of functions (ϕ, ψ) , called *H -topological-minor model* such that ϕ is an injection of $V(H) \rightarrow V(G)$ and ψ sends $\{u, v\}_i$ to a path of G between $\phi(u)$ and $\phi(v)$, for every $\{u, v\} \in E(H)$ and every $i \in \{1, \dots, \text{mult}_H(\{u, v\})\}$, in a way such that distinct edges are sent to internally vertex-disjoint paths. Every vertex in the image of ϕ is called a *branch vertex*. Observe that if (ϕ, ψ) is an H -topological-minor model in G then (ϕ, ψ) is an H -strong-immersion model in G .

For the proof of the vertex case of [Theorem 1](#), we require the following two “vertex counterparts” of [Theorem 4](#) and [Lemma 7](#) respectively.

Proposition 2. *Let \mathcal{H} be a class of connected graphs and let t be a non-negative integer. Then \mathcal{H} has the v-E&P property for the graphs of treewidth at most t with a gap that is a polynomial function on t .*

Lemma 8. *Let G be a graph and let H be a connected planar graph on h vertices and without any $\mathcal{I}(H)$ -vertex packing of size greater than k . Then $\text{tw}(G) = (h \cdot k)^{O(1)}$.*

[Proposition 2](#) was proven by Thomassen in [\[27\]](#) (see also [\[4, 12\]](#)). For [Lemma 8](#), we need the fact that there is a polynomial function $\lambda : \mathbb{N}^+ \rightarrow \mathbb{N}$ such that for every $r \in \mathbb{N}^+$, every graph with treewidth at least $\lambda(r)$ contains

W_r as a topological minor. The existence of such a function λ follows from the *grid exclusion theorem* of Robertson and Seymour in [25] (see also [8, 24]) and the polynomiality of λ was proved recently by Chekuri and Chuzhoy in [5] (see also [6, 7] for improvements). Then Lemma 8 can be proved using the same arguments as in Lemma 7, taking into account that Lemma 6 also holds if we consider topological minors instead of immersions and the fact that a topological minor model is also an immersion model.

The vertex version of Theorem 1 follows from Proposition 2 and Lemma 8 if, in Proposition 2, we set $\mathcal{H} = \mathcal{I}(H)$ and $t = (h \cdot k)^{O(1)}$.

7 Discussion

Notice that in Theorem 1 we demand that H is a connected graph. It is easy to extend this result if instead of H we consider some finite collection \mathcal{H} of connected graphs, at least one of which is planar subcubic, and where we define $\mathcal{I}(\mathcal{H})$ as the class of all graphs containing some graph in \mathcal{H} as an immersion. Moreover, it is possible to drop the connectivity condition for the vertex variant using arguments from [25], to the price of a slight increase of the gap. However it remains open whether this can be done for the edge variant as well.

Naturally, the most challenging problem on the Erdős–Pósa properties of immersions is to characterize the graph classes:

$$\mathcal{H}^{\vee/e} = \{H \mid \mathcal{I}(H) \text{ has the } \vee/e\text{-E\&P property}\}$$

In this paper we prove that both \mathcal{H}^{\vee} and \mathcal{H}^e contain all planar subcubic graphs. It is an interesting question whether $\mathcal{H}^{\vee/e}$ are wider than this. Using arguments similar to [22, 25] it is possible to prove the following.

Lemma 9. *None of \mathcal{H}^{\vee} and \mathcal{H}^e contains a non-planar subcubic graph.*

Actually, the arguments of [22, 25] permit to exclude all non-planar graphs from \mathcal{H}^{\vee} . For the non-subcubic case, we can first observe that $K_{1,4}$, which is planar and non-subcubic belongs to both \mathcal{H}^{\vee} and \mathcal{H}^e . However, this is not the case for all planar and non-subcubic graphs as is indicated in the following observation.

Observation 4. *There exists a 3-connected non-subcubic planar graph H that does belong neither to \mathcal{H}^{\vee} nor to \mathcal{H}^e .*

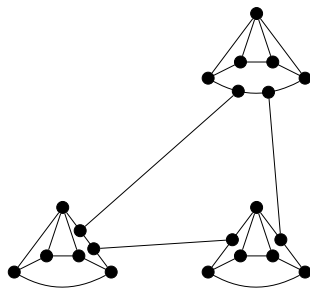

Figure 4: A biconnected graph H for which $\mathcal{I}(H)$ does not have the v/e-E&P property.

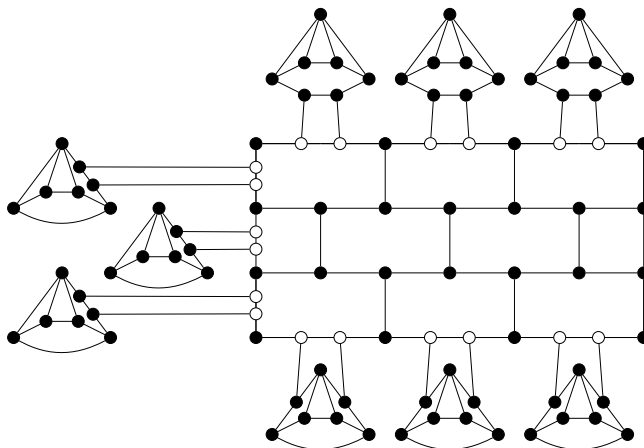



Figure 5: The host graph G .

Proof. Thomassen in [27] provided an example of a tree that does not belong in \mathcal{H}^v (the same graph does not belong in \mathcal{H}^e either). Inspired by the construction of [27], we consider first the graph H is depicted in Figure 4. To see that $H \notin \mathcal{H}^v$ and $H \notin \mathcal{H}^e$, consider as host graph G the graph in Figure 5. This graph consists of a main body that is a wall of height 3 and three triples of graphs attached at its upper, leftmost, and lower paths. Each of these triples consists of three copies of some of the 3-connected components of H . Notice that G does not contain more than one H -immersion expansion. However, in order to cover all H -immersion expansions of G one needs to remove at least 3 edges/vertices. By increasing the height of the wall of G , we may increase the minimum size of an $\mathcal{I}(H)$ -vertex/edge cover while no $\mathcal{I}(H)$ -vertex/edge packing of size greater than 1 will appear. It is easy to

modify H so to make it 3-connected: just add a new vertex and make it adjacent with the tree vertices of degree 4. The resulting graph H' remains planar. The same arguments, applied to an easy modification of the host graph, can prove that H' is not a graph in \mathcal{H}^v or \mathcal{H}^e . \square

Providing an exact characterization of \mathcal{H}^v and \mathcal{H}^e is an insisting open problem. A first step to deal with this problem could be the cases of $\theta_4 =$  and the 4-wheel . Especially for the 4-wheel, the structural results in [1] might be useful in this direction.

References

- [1] Rémy Belmonte, Archontia Giannopoulou, Daniel Lokshtanov, and Dimitrios M. Thilikos. The Structure of W_4 -Immersion-Free Graphs. *preprint*, arxiv.org/abs/1602.02002, 2016.
- [2] Etienne Birmelé, John Adrian Bondy, and Bruce A. Reed. The Erdős-Pósa property for long circuits. *Combinatorica*, 27(2):135–145, 2007.
- [3] Dimitris Chatzidimitriou, Jean-Florent. Raymond, Ignasi Sau, and Dimitrios M. Thilikos. Minors in graphs of large θ_r -girth. *preprint*, arxiv.org/abs/1510.03041, 2015.
- [4] Chandra Chekuri and Julia Chuzhoy. Large-treewidth graph decompositions and applications. In *STOC'13—Proceedings of the 2013 ACM Symposium on Theory of Computing*, pages 291–300. ACM, New York, 2013.
- [5] Chandra Chekuri and Julia Chuzhoy. Polynomial bounds for the grid-minor theorem. In *STOC'14—Proceedings of the 2014 ACM Symposium on Theory of Computing*, pages 60–69. ACM, New York, 2014.
- [6] Julia Chuzhoy. Excluded grid theorem: improved and simplified. In *STOC'15—Proceedings of the 2015 ACM Symposium on Theory of Computing*, pages 645–654. ACM, New York, 2015.
- [7] Julia Chuzhoy. Improved bounds for the excluded grid theorem. *preprint*, arxiv.org/abs/1602.02629, 2016.
- [8] Reinhard Diestel. *Graph Theory*, volume 173 of *Graduate Texts in Mathematics*. Springer-Verlag, Heidelberg, third edition, 2005.

- [9] Reinhard Diestel, Ken-ichi Kawarabayashi, and Paul Wollan. The Erdős–Pósa property for clique minors in highly connected graphs. *Journal of Combinatorial Theory. Series B*, 102(2):454 – 469, 2012.
- [10] Guoli Ding and Bogdan Oporowski. On tree-partitions of graphs. *Discrete Mathematics*, 149(1-3):45–58, 1996.
- [11] Paul Erdős and Louis Pósa. On independent circuits contained in a graph. *Canadian Journal of Mathematics*, 17:347–352, 1965.
- [12] Fedor V. Fomin, Saket Saurabh, and Dimitrios M. Thilikos. Strengthening Erdős–Pósa property for minor-closed graph classes. *Journal of Graph Theory*, 66(3):235–240, 2011.
- [13] Robert Ganian, Eun Jung Kim, and Stefan Szeider. Algorithmic applications of tree-cut width. In *Mathematical foundations of computer science 2015. Part II*, volume 9235 of *Lecture Notes in Comput. Sci.*, pages 348–360. Springer, Heidelberg, 2015.
- [14] Jim Geelen and Kasper Kabell. The Erdős–Pósa property for matroid circuits. *Journal of Combinatorial Theory. Series B*, 99(2):407–419, 2009.
- [15] Rudolf Halin. Tree-partitions of infinite graphs. *Discrete Mathematics*, 97(1–3):203 – 217, 1991.
- [16] Naonori Kakimura and Ken-ichi Kawarabayashi. Fixed-parameter tractability for subset feedback set problems with parity constraints. *Theoretical Computer Science*, 576:61–76, 2015.
- [17] Goos Kant. Drawing planar graphs using the canonical ordering. *Algorithmica*, 16(1):4–32, 1996.
- [18] Ken-ichi Kawarabayashi and Atsuhiko Nakamoto. The erdős–pósa property for vertex- and edge-disjoint odd cycles in graphs on orientable surfaces. *Discrete Mathematics*, 307(6):764 – 768, 2007.
- [19] Daniel Král’ and Heinz-Jürgen Voss. Edge-disjoint odd cycles in planar graphs. *Journal of Combinatorial Theory. Series B*, 90(1):107 – 120, 2004.
- [20] Chun-Hung Liu. Packing and covering immersions in 4-edge-connected graphs. *preprint*, arxiv.org/abs/1505.00867, 2015.

- [21] Dieter Rautenbach and Bruce A. Reed. The erdos-pósa property for odd cycles in highly connected graphs. *Combinatorica*, 21(2):267–278, 2001.
- [22] Jean-Florent Raymond, Ignasi Sau, and Dimitrios M. Thilikos. An edge variant of the Erdős-Pósa property. *preprint*, arxiv.org/abs/1311.1108, 2013.
- [23] Bruce A. Reed, Neil Robertson, Paul D. Seymour, and Robin Thomas. Packing directed circuits. *Combinatorica*, 16(4):535–554, 1996.
- [24] Neil Robertson, Paul Seymour, and Robin Thomas. Quickly excluding a planar graph. *Journal of Combinatorial Theory. Series B*, 62(2):323–348, 1994.
- [25] Neil Robertson and Paul D. Seymour. Graph Minors. V. Excluding a planar graph. *Journal of Combinatorial Theory. Series B*, 41(2):92–114, 1986.
- [26] Detlef Seese. Tree-partite graphs and the complexity of algorithms. In *Proceedings of Fundamentals of Computation Theory*, volume 199 of *Lecture Notes in Computer Science*, pages 412–421. Springer Berlin Heidelberg, 1985.
- [27] Carsten Thomassen. On the presence of disjoint subgraphs of a specified type. *Journal of Graph Theory*, 12(1):101–111, 1988.
- [28] Paul Wollan. The structure of graphs not admitting a fixed immersion. *Journal of Combinatorial Theory. Series B*, 110:47–66, 2015.