

An aperiodic set of 11 Wang tiles

Emmanuel Jeandel ¹ Michaël Rao ²

¹LORIA - Nancy

²LIP - Lyon

A Wang tile is a square tile with a color on each border

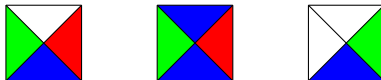

Given a set of Wang tiles, one try to tile the plane with copies of tiles in the set s.t. two adjacent sides have the same color

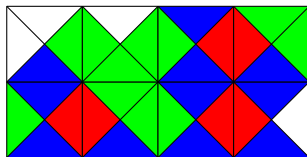

(No rotations !)

A tiling of the plane is *periodic* if there is a translation vector which does not change the tiling

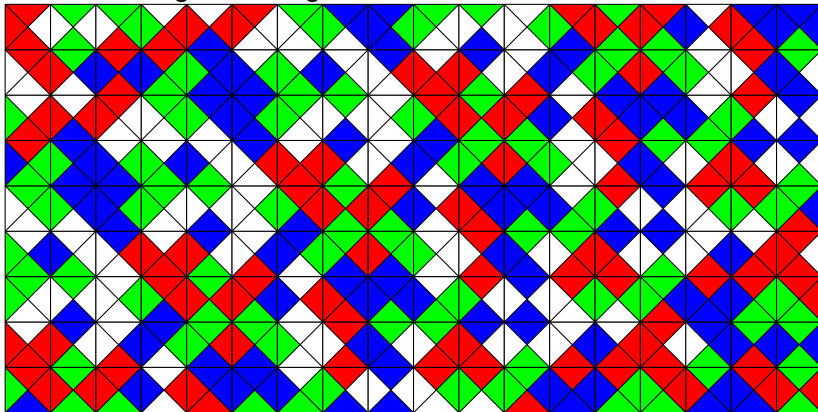

A tile set is *periodic* if there is a periodic tiling of the plane with this set

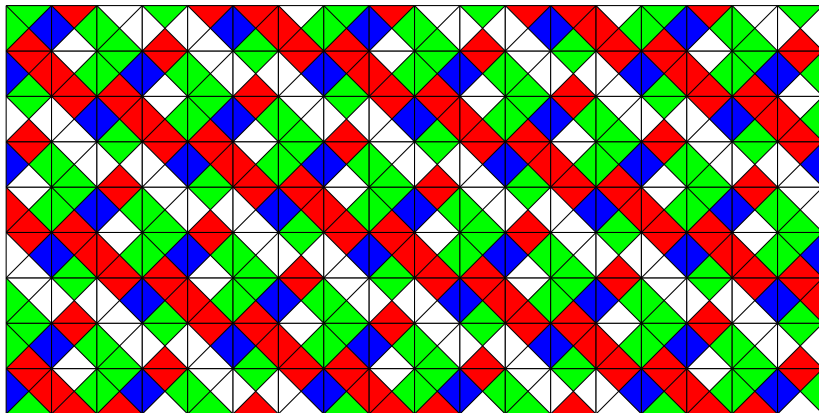

A set is periodic if and only if there is a tiling with 2 (not colinear) translation vectors

A set is *finite* if there is no tiling of the plane with this set

A set is *aperiodic* if it tiles the plane, but no tiling is periodic

Conjecture (Wang 1961)

Every set is either finite or periodic

False:

Theorem (Berger 1966)

It exists an aperiodic set of Wang tiles

History

- Berger : 20426 tiles in 1966 (lowered down later to 104)
- Knuth : 92 tiles in 1968
- Robinson : 56 tiles in 1971
- Ammann : 16 tiles in 1971
- Grunbaum : 24 tiles in 1987
- Kari : 14 tiles in 1996
- Culik : (same method) 13 tiles in 1996
- Here : 11 tiles (the fewest possible)

“Kari & Culik” tile set

Theorem (Culik 1996)

The following set (13 tiles) is aperiodic

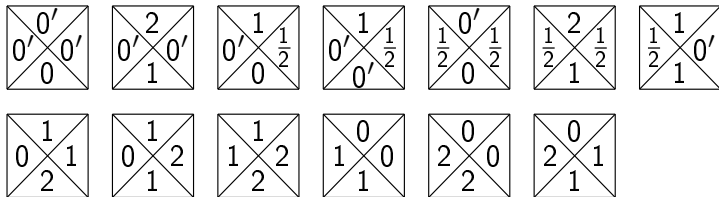

New results

Theorem

Every set with at most 10 Wang tiles is either finite or periodic

Theorem

There is a set with 11 Wang tiles which is aperiodic

Transducer

A set of Wang tiles can be seen as a transducer

A *transducer* is a finite automaton where each transition has an input letter and an output letter

$$\mathcal{T} = (H, V, T) \text{ where } T \subseteq H^2 \times V^2$$

We note $w\mathcal{T}w'$ if the transducer \mathcal{T} writes w' when it reads w

(Transducer on $\Sigma =$ Automaton on Σ^2)

“Kari & Culik” tile set

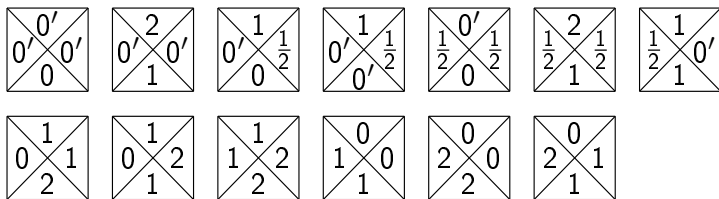
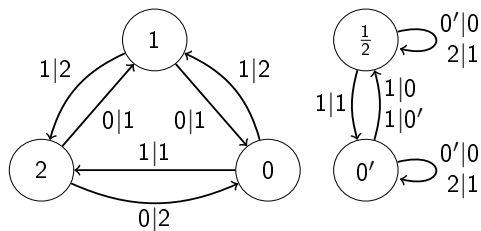

Figure: Kari & Culik tile set.

Simplification

If \mathcal{T} has a transition a between two strongly connected components, then \mathcal{T} is finite (resp. periodic) if and only if $\mathcal{T} \setminus \{a\}$ is finite (resp. periodic)

Let $s(\mathcal{T})$ be the union of strongly connected components of \mathcal{T}
 \mathcal{T} is finite (resp. periodic, aperiodic) if and only if $s(\mathcal{T})$ is finite (resp. periodic, aperiodic)

Composition and power

Let $\mathcal{T} = (H, V, T)$ and $\mathcal{T}' = (H', V, T)$ be two transducers

Then $\mathcal{T} \circ \mathcal{T}' = (H \times H', V, T'')$ where:

$$T'' = \{((w, w'), (e, e'), s, n') : (w, e, s, x) \in T, (w', e', x, n')\}$$

$$\mathcal{T}^k = \mathcal{T}^{k-1} \circ \mathcal{T}$$

Power

Proposition

There is $k \in \mathbb{N}$ s.t. $s(\mathcal{T}^k)$ is empty iff \mathcal{T} is finite

Proposition

There is $k \in \mathbb{N}$ s.t. there is a bi-infinite word w such that $w\mathcal{T}^k w$ iff \mathcal{T} is periodic

Enumeration (I)

To enumerate all sets with n tiles, we compute all oriented graphs with n arrows (with loops and multiple arrows)

For every pair of graphs G and G' , we try every $n!$ bijections between the arrows of G and G'

We only consider graphs without arrows between two strongly connected components.

n	nb. graphs
8	2518
9	13277
10	77810
11	493787

Enumeration (II)

For every generated set \mathcal{T} , we compute $s(\mathcal{T}^k)$ until:

- $s(\mathcal{T}^k)$ is empty \rightarrow the set is finite
- $\exists w$ s.t. $ws(\mathcal{T}^k)w \rightarrow$ is periodic
- The computer run out of memory \rightarrow the computer cannot conclude...

Optimizations :

- Cut branches in the exploration of $n!$ bijections
- Make tests on \mathcal{T} and \mathcal{T}^{tr} on the same time
- Use (sometimes) bi-simulation to simplify transducers

Result ($n \leq 10$)

Theorem

Every set of n Wang tile, $n \leq 10$, is finite or periodic

- ~ 4 days on ~ 100 cores
- Only one problematic case

The only problematic case with 10 tiles

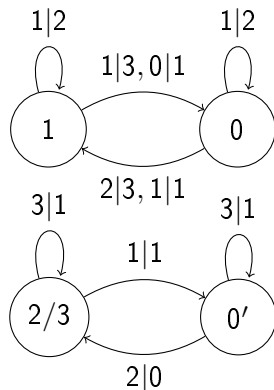

Kari type construction with $\times 2$, $\times \frac{1}{3}$ (Tuesday's talk of Jarkko)

- If it tiles, then it is aperiodic
- It is a strict subset of the Kari's construction. Does it tiles ?
- We have to use compactness to show that : No

Aperiodic set of 11 tiles

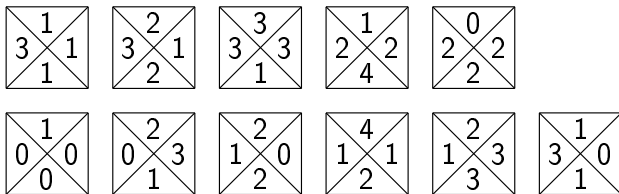
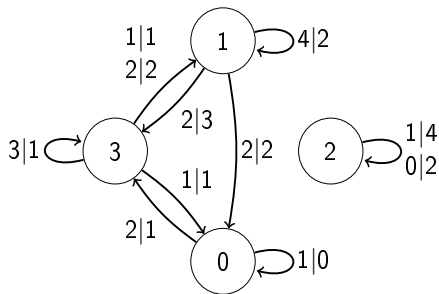

Proof (squetch.)

Theorem

\mathcal{T} is aperiodic

Ideas:

- It is the union of two transducers \mathcal{T}_0 and \mathcal{T}_1 (as for Kari & Culik)
- In a tiling by \mathcal{T} , we can merge layers into \mathcal{T}_{10000} and \mathcal{T}_{1000}
- We get a new transducer \mathcal{T}_D with 28 transitions, which is the union of $\mathcal{T}_a \simeq \mathcal{T}_{10000}$ and $\mathcal{T}_b \simeq \mathcal{T}_{1000}$
- We define the family \mathcal{T}_n , with $\mathcal{T}_{n+3} = \mathcal{T}_{n+1} \circ \mathcal{T}_n \circ \mathcal{T}_{n+1}$
- We show $\mathcal{T}_b = \mathcal{T}_0$, $\mathcal{T}_{aa} = \mathcal{T}_1$, $\mathcal{T}_{bab} = \mathcal{T}_2$
- The only admissible vertical word for \mathcal{T}_D is the Fibonacci word

\mathcal{T} is the union of \mathcal{T}_0 and \mathcal{T}_1 , with (resp.) 9 and 2 tiles
For $w \in \{0, 1\}^* \setminus \{\epsilon\}$, let $\mathcal{T}_w = \mathcal{T}_{w[1]} \circ \mathcal{T}_{w[2]} \circ \dots \circ \mathcal{T}_{w[|w|]}$

Fact

$s(\mathcal{T}_{11}), s(\mathcal{T}_{101}), s(\mathcal{T}_{1001})$ and $s(\mathcal{T}_{00000})$ are empty

If t is a tiling by \mathcal{T} , then there exists a bi-infinite word
 $w \in \{1000, 10000\}^{\mathbb{Z}}$ s.t. $t(x, y) \in \mathcal{T}(\mathcal{T}_{w[y]})$

Let $\mathcal{T}_A = s(\mathcal{T}_{1000} \cup \mathcal{T}_{10000})$

There is a bijection between tilings by \mathcal{T} and tilings by \mathcal{T}_A

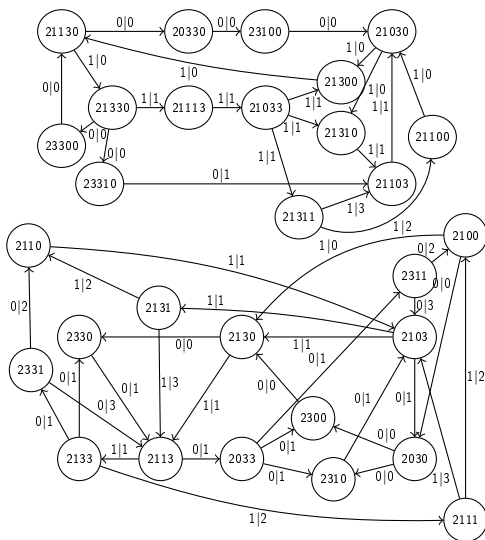

Figure: \mathcal{T}_A , the union of $s(\mathcal{T}_{10000})$ (top) and $s(\mathcal{T}_{1000})$ (bottom).

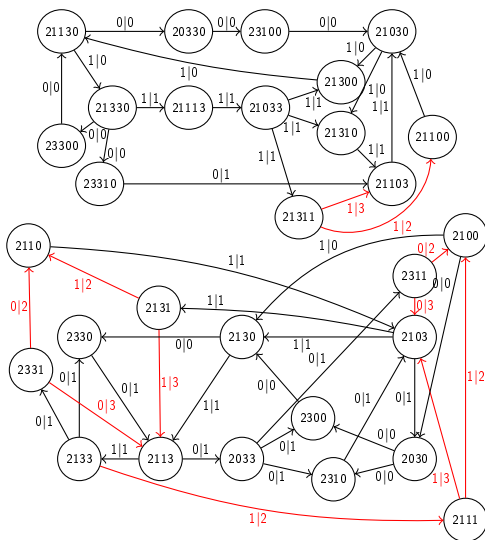

Figure: \mathcal{T}_A , the union of $s(\mathcal{T}_{10000})$ (top) and $s(\mathcal{T}_{1000})$ (bottom).

Elimination of transitions with 2, 3 or 4

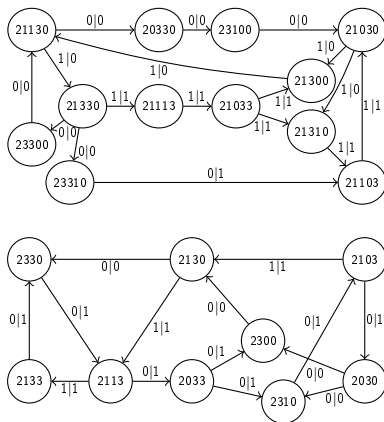

Figure: $\mathcal{T}_B = s(s(\mathcal{T}_A^{\text{tr}})^{\text{tr}})$.

Simplification by bi-simulation

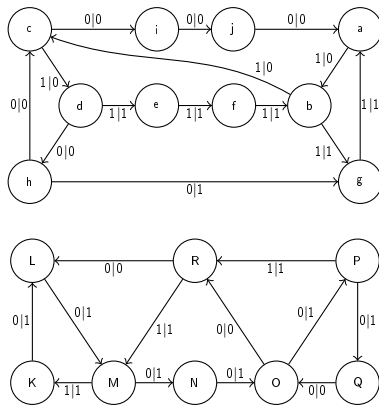

Figure: \mathcal{T}_C , “simplification” of \mathcal{T}_B .

Proposition

Let $(w_i)_{i \in \mathbb{Z}}$ be a bi-infinite sequence of bi-infinite words s.t.
 $w_i \mathcal{T}_C w_{i+1}$ for every $i \in \mathbb{Z}$.

Then for every $i \in \mathbb{Z}$, w_i is (010, 101)-free

This follow from the fact than $s((\mathcal{T}_C^{\text{tr}})^3)$ does not contains the state 010, nor the state 101

Every tiling by \mathcal{T}_C is in bijection with a tiling by \mathcal{T}_D

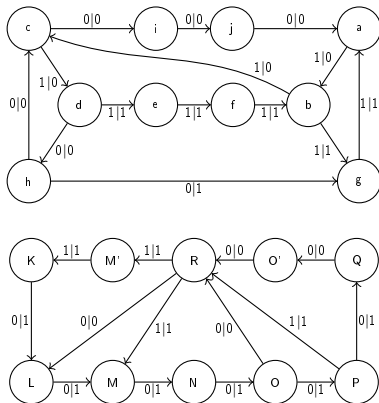
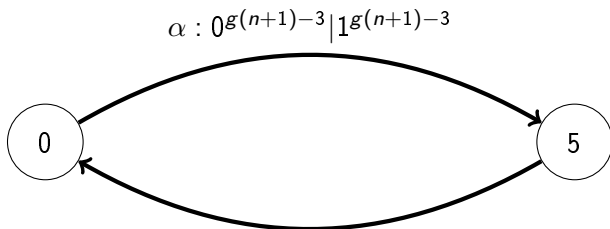

Figure: \mathcal{T}_D , the union of \mathcal{T}_a (top) and \mathcal{T}_b (bottom)

T_n for even n :



$$\begin{array}{l}
 \beta : 0^{g(n)+3} \quad | (100)1^{g(n)} \\
 \gamma : 0^{g(n+2)+3} \quad | 1^{g(n+1)}(000)1^{g(n)} \\
 \delta : 0^{g(n)}(111)0^{g(n+1)} \quad | 1^{g(n+2)+3} \\
 \epsilon : 0^{g(n)}(110) \quad | 1^{g(n)+3} \\
 \omega : 0^{g(n+2)}(110)0^{g(n)} \quad | 1^{g(n)}(100)1^{g(n+2)}
 \end{array}$$

$g(n)$ is the $(n+2)$ -th Fibonacci number: $g(0) = 2, g(1) = 3,$
 $g(n+2) = g(n+1) + g(n)$

T_n for odd n :

$$A : 1^{g(n+1)-3} | 0^{g(n+1)-3}$$

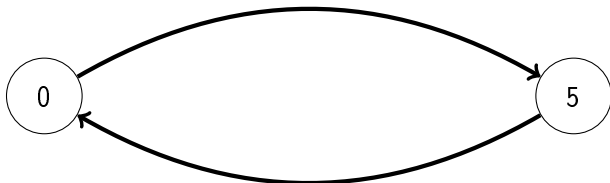

$$\begin{array}{l}
 B : 1^{g(n)+3} \quad | (110)0^{g(n)} \\
 C : 1^{g(n+2)+3} \quad | 0^{g(n+1)}(111)0^{g(n)} \\
 D : 1^{g(n)}(000)1^{g(n+1)} \quad | 0^{g(n+2)+3} \\
 E : 1^{g(n)}(100) \quad | 0^{g(n)+3} \\
 O : 1^{g(n+2)}(100)1^{g(n)} \quad | 0^{g(n)}(110)0^{g(n+2)}
 \end{array}$$

$g(n)$ is the $(n+2)$ -th Fibonacci number: $g(0) = 2, g(1) = 3,$
 $g(n+2) = g(n+1) + g(n)$

Case of \mathcal{T}_b

In \mathcal{T}_b , every long enough path passes through “N”
 Thus \mathcal{T}_b is equivalent to:

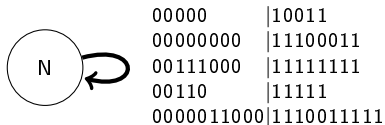
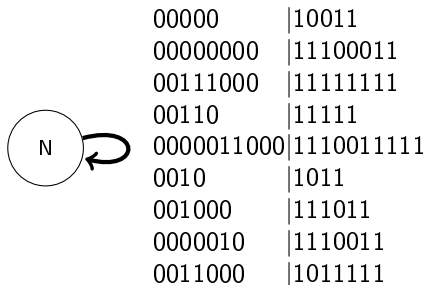

Case of \mathcal{T}_{aa}

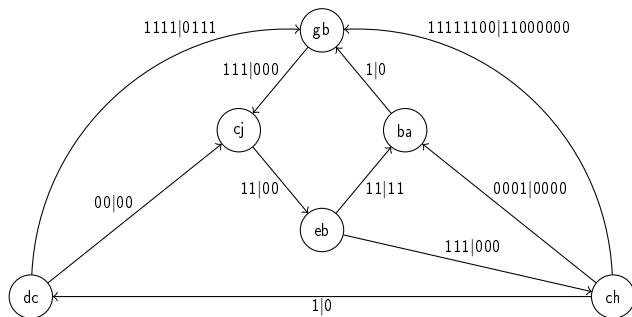
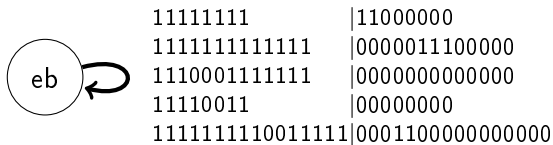
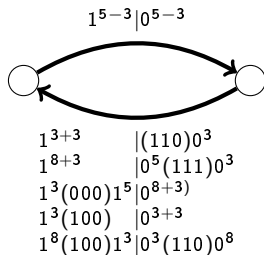

Figure: $s(\mathcal{T}_{aa})$

In $s(\mathcal{T}_{aa})$, every long path passes through “eb”. It is equivalent to:



\mathcal{T}_{aa} is equivalent to T_1



Case of \mathcal{T}_{bab}

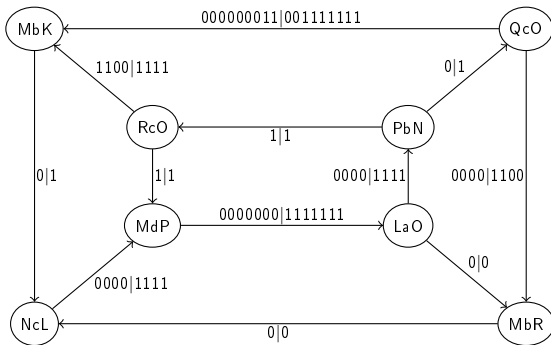
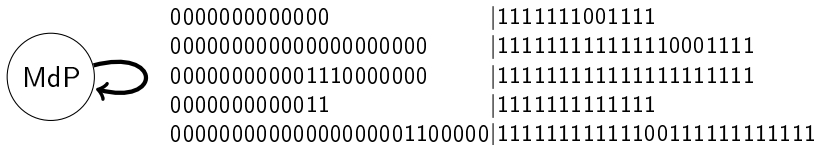
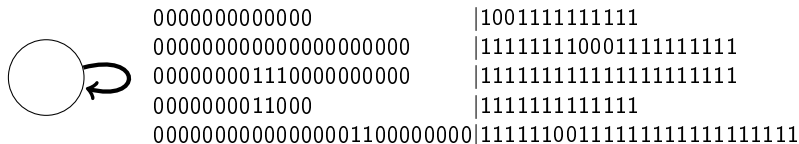

Figure: $s(\mathcal{T}_{bab})$

Every long path passes through “MdP”. Thus it is equivalent to :



If we shift the input (3 times) and the output (6 times), we get:



\mathcal{T}_{bab} is equivalent to \mathcal{T}_2

Fact

$s(\mathcal{T}_{bb}), s(\mathcal{T}_{aaa})$ and $s(\mathcal{T}_{babab})$ are empty

If t is a tiling by \mathcal{T}_D , then there is a bi-infinite word $w \in \{b, aa, bab\}^{\mathbb{Z}}$ s.t. $t(x, y) \in T(\mathcal{T}_{w[y]})$

That is, the tilings with \mathcal{T}_D are images of the tilings by

$$\mathcal{T}_b \cup \mathcal{T}_{aa} \cup \mathcal{T}_{bab} \simeq T_0 \cup T_1 \cup T_2.$$

T_n for even n :

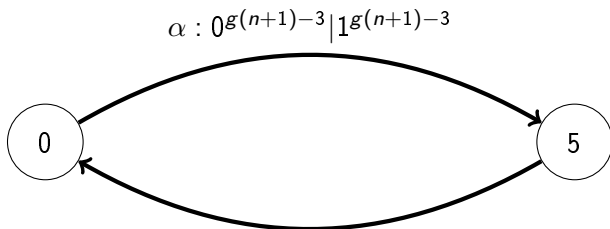

$$\begin{array}{l}
 \beta : 0^{g(n)+3} \quad | (100)1^{g(n)} \\
 \gamma : 0^{g(n+2)+3} \quad | 1^{g(n+1)}(000)1^{g(n)} \\
 \delta : 0^{g(n)}(111)0^{g(n+1)} \quad | 1^{g(n+2)+3} \\
 \epsilon : 0^{g(n)}(110) \quad | 1^{g(n)+3} \\
 \omega : 0^{g(n+2)}(110)0^{g(n)} \quad | 1^{g(n)}(100)1^{g(n+2)}
 \end{array}$$

$g(n)$ is the $(n+2)$ -th Fibonacci number: $g(0) = 2, g(1) = 3,$
 $g(n+2) = g(n+1) + g(n)$

T_n for odd n :

$$A : 1^{g(n+1)-3} | 0^{g(n+1)-3}$$

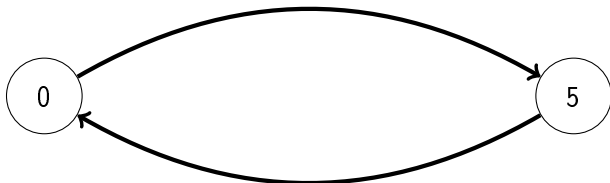

$$\begin{array}{l}
 B : 1^{g(n)+3} \quad | (110)0^{g(n)} \\
 C : 1^{g(n+2)+3} \quad | 0^{g(n+1)}(111)0^{g(n)} \\
 D : 1^{g(n)}(000)1^{g(n+1)} \quad | 0^{g(n+2)+3} \\
 E : 1^{g(n)}(100) \quad | 0^{g(n)+3} \\
 O : 1^{g(n+2)}(100)1^{g(n)} \quad | 0^{g(n)}(110)0^{g(n+2)}
 \end{array}$$

$g(n)$ is the $(n+2)$ -th Fibonacci number: $g(0) = 2, g(1) = 3,$
 $g(n+2) = g(n+1) + g(n)$

One supposes that n is even. (The odd case is similar.)

One supposes that $T_n \cup T_{n+1} \cup T_{n+2}$ tiles the plane

We show that $T_{n+1} \cup T_{n+2} \cup T_{n+3}$ tiles, and that:

$$T_{n+3} \simeq T_{n+1} \circ T_n \circ T_{n+1}.$$

T_n is surrounded by T_{n+1}

(output of T_{n+1} has more 0's than 1's, T_n and output T_{n+2} have more 1's than 0's)

Transitions of T_n :

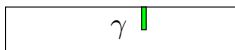
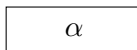
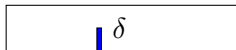
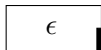

Transitions of T_{n+1} :

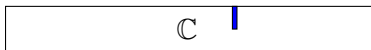
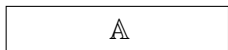
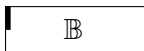
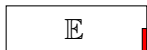

Let's take T_n . (We forget α .)

Lemma

The following words cannot appear:

- $\gamma\omega, \gamma\gamma, \gamma\beta, \beta\omega, \beta\beta, \beta\epsilon\beta, \gamma\epsilon\beta, \beta\delta\epsilon\beta, \gamma\delta\epsilon\beta$
- $\omega\delta, \delta\delta, \epsilon\delta, \omega\epsilon, \epsilon\epsilon, \epsilon\beta\epsilon, \epsilon\beta\delta, \epsilon\beta\gamma\epsilon, \epsilon\beta\gamma\delta$
- ω

Lemma

Every infinite path in the transducer \mathcal{T}_n can be seen as an infinite path in the following transducer:

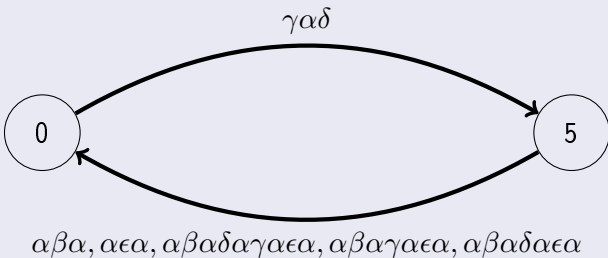

$$\gamma\delta \rightarrow A'$$

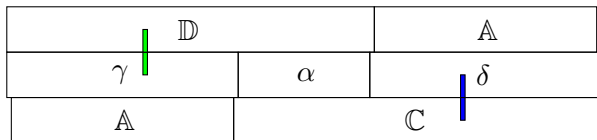

$$\epsilon \rightarrow B'$$

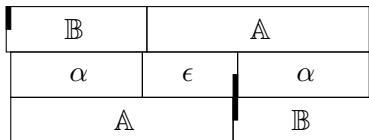

$\beta \rightarrow \mathbb{E}'$:

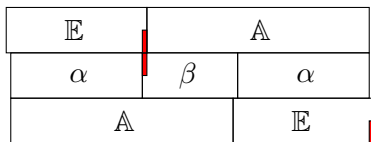

$\beta\gamma\epsilon \rightarrow \mathbb{C}'$:

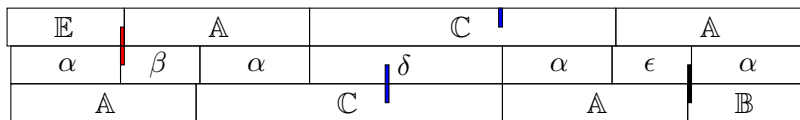

$\beta\delta\epsilon \rightarrow \mathbb{D}'$:

E	A	D	A
α	β	α	α
A	D	A	B

$\beta\delta\gamma\epsilon \rightarrow \mathbb{O}'$:

E	A	B	A	D	A
α	β	α	δ	α	α
A	C	A	E	A	B

It remains to show that one cannot have a stack of layers
 $T_{n+1}, T_n, T_{n+1}, T_n, T_{n+1}$

We can merge layers of a tiling with $T_n \cup T_{n+1} \cup T_{n+2}$ by:

- 1 T_{n+1}
- 2 T_{n+2}
- 3 $T_{n+1} T_n T_{n+1} \simeq T_{n+3}$

$T_n \simeq \mathcal{T}_{u_n}$ where:

$$u_0 = b, u_1 = aa, u_2 = bab$$

and

$$u_{n+3} = u_{n+1}u_nu_{n+1}$$

$$(u_n)_{n \geq 0} = (b, aa, bab, aabaa, babaabab, \dots)$$

is a sequence of factors of the Fibonacci word
(the “singular factors”)

Fibonacci Word

Aperiodic word

$$w_f = abaababaabaababaababaabaababaabababaa\dots$$

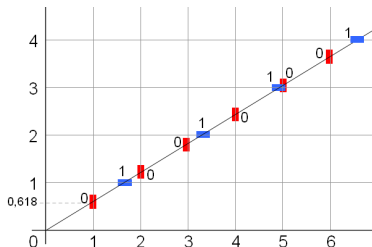

Fixed point of the morphism $a \rightarrow ab, b \rightarrow a$

$$v_0 = a, v_1 = ab \quad \text{and} \quad v_{n+2} = v_{n+1}v_n$$

v_i converges to w_f

$$(v_n)_{n \geq 0} = (a, \underline{ab}, \underline{aba}, \underline{abaab}, \underline{abaababa}, \underline{abaababaabaab}, \dots)$$

$$(u_n)_{n \geq 0} = (b, \underline{aa}, \underline{bab}, \underline{aabaa}, \underline{babaabab}, \underline{aabaababaabaa}, \dots)$$

Aperiodic set with 11 tiles

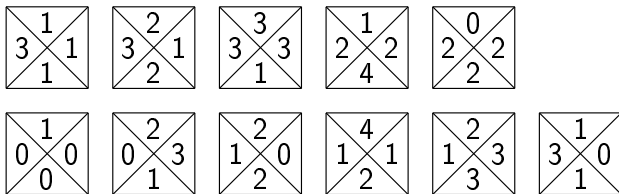
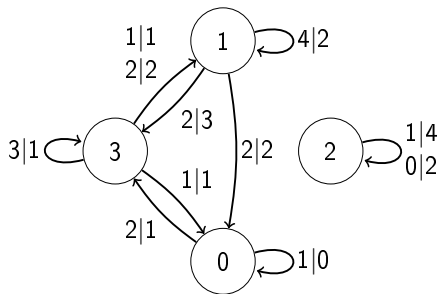

Aperiodic set with 11 tiles and 4 colors

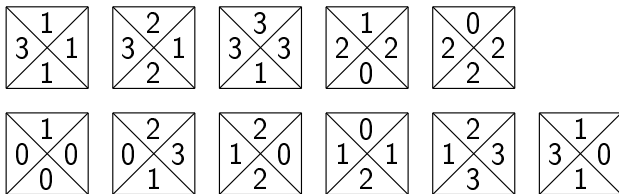
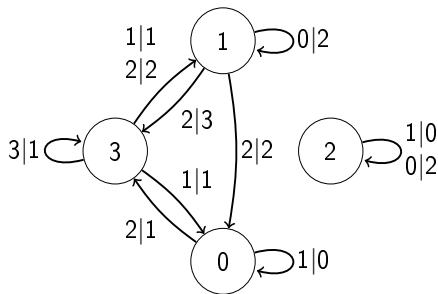

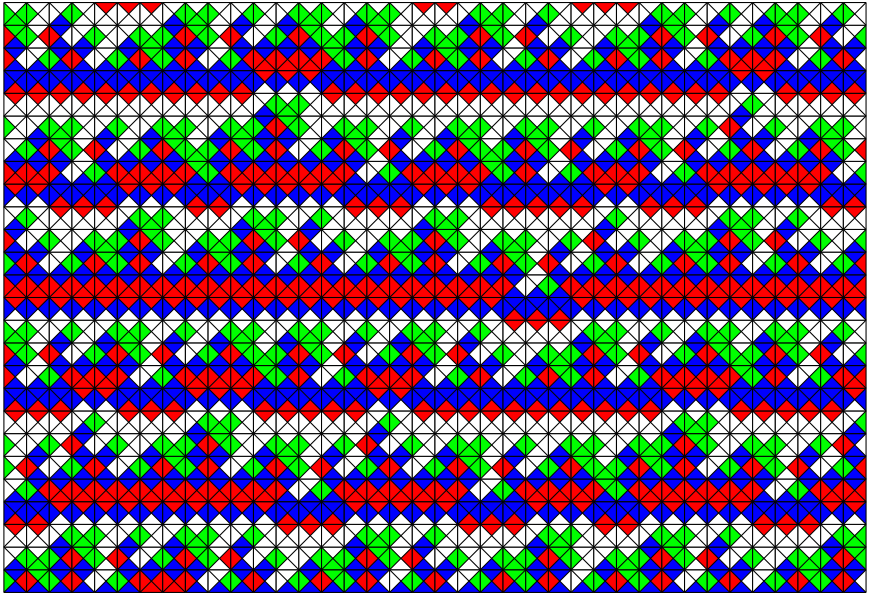

Open question 1 : Another aperiodic set ?

Tiles sets with 11 tiles:

- 2 aperiodic (and 1 other probably very close)
- 23 others “candidates”
- 9 of “Kari” type, and probably finite
- 14 not “Kari” type
- 1 strange (interesting) candidate:

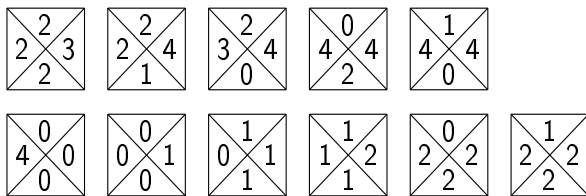

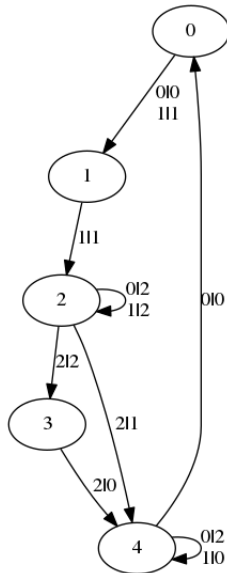

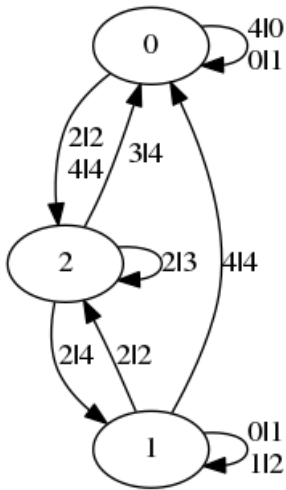

Open question 2 : “proof from the book” ?

If we look at densities of 1 on each line on an infinite tiling, one transducer add $\varphi - 1$ and the other add $\varphi - 2$.

→ “additive-Kari-type” ?

